

Collezione letti / Bed collection
Technical Book

Design
italiano,
stile
contemporaneo

ENNEREV®

La nuova collezione Letti
di Ennerev è una sinfonia
di comfort e stile.

Ogni pezzo è pensato
per adattarsi ai tuoi sogni,
trasformando ogni notte
in un'esperienza unica
e indimenticabile.

The new Ennerev Beds Collection is a symphony of comfort and style. Each model is designed to fit your dreams, changing every night into a unique and unforgettable experience.

ENNEREV®

INDICE / INDEX

WAVE

4



ISABEL

10



MATRIX

16



FOLDER

22



HORIZON

28



BALTIMORA

34



OLSEN

40



VIVIENNE

46



NEST

54



ARCADIA

58



FREYA

66



VENTURA

74



VENTURA MAXI
80



SOPHIE
86



ATLAS
92



BASIC SOMMIER
100



MY SPACE
SIRIO 108



MY SPACE
NAOS 112



POUF
114



ISTRUZIONI DI
MONTAGGIO/
ASSEMBLING
INSTRUCTIONS
120

TESSUTI /
FABRICS
130

PIEDINI / FEET
142

WAVE

Scheda tecnica / Technical data

Wave è un letto imbottito, completamente sfoderabile e disponibile in due diverse altezze di giroletto: 28 cm., sia con box standard che con sistema easy-up e 22 cm., disponibile anche con box contenitore. Realizzabile in diverse dimensioni, il letto Wave può essere personalizzato con piedini dalle diverse tipologie e finiture: piedini di altezza 8 cm. e di serie di 4 cm. per il giroletto da 28 cm., piedini di altezza 8 cm. per il giroletto da 22 cm.

Wave is an upholstered bed, completely removable and available in two bed frame heights: 28 cm., available with standard storage box and easy-up box system, and 22 cm., available with storage box. Available in different size, the Wave bed can be customized with feet of different types, height and finishes: 8 cm. feet and standard 4 cm. feet for the 28 cm. bed frame, 8 cm. feet for the 22 cm. bed frame.



Immagine in alto
testiera / giroletto: Spice 1
piedini: cilindro nero laccato h. 4 cm.
Immagine in basso
testiera / giroletto: Cali 786
piedini: sagomato wengé h. 8 cm.

4

Image above
headboard / bed frame: Spice 1
feet: black lacquered cylinder h. 4 cm.
Image below
headboard / bed frame: Cali 786
feet: wenge shaped h. 8 cm.



igiene sicura sfoderabile
e lavabile / safe hygiene
removable and washable



DIMENSIONI DISPONIBILI / AVAILABLE SIZES

piazza e mezza 120x190 / 120x200 cm.
matrimoniale 160x190 / 160x200 cm.
matrimoniale xl 180x190 / 180x200 cm.
queen 153x203 cm.
king 193x203 cm.
matrimoniale xxl 200x200 cm.

*three-quarter size 120x190 / 120x200 cm.
double bed 160x190 / 160x200 cm.
double bed xl 180x190 / 180x200 cm.
queen 153x203 cm.
king 193x203 cm.
double bed xxl 200x200 cm.*

H. 28 GIROLETTO BED FRAME

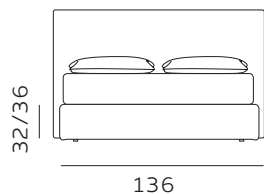

136
materasso largh. cm. 120
mattress width cm. 120

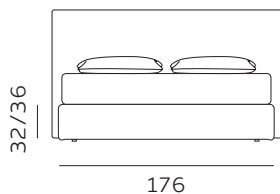

176
materasso largh. cm. 160
mattress width cm. 160

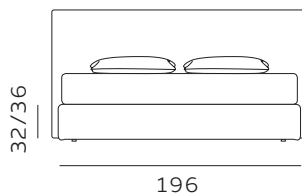

196
materasso largh. cm. 180
mattress width cm. 180

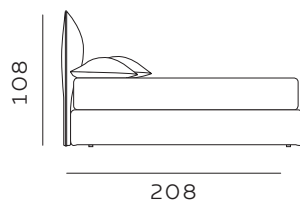

208
materasso lungh. cm. 190
mattress length cm. 190

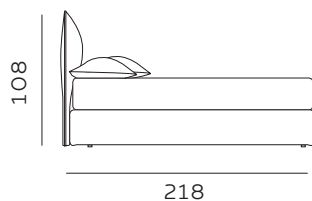

218
materasso lungh. cm. 200
mattress length cm. 200

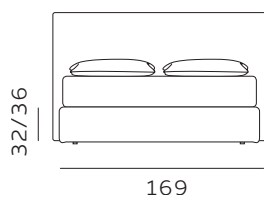

169
materasso largh. cm. 153
mattress width cm. 153

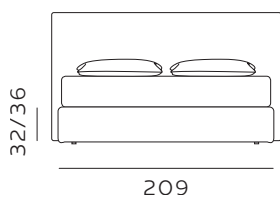

209
materasso largh. cm. 193
mattress width cm. 193

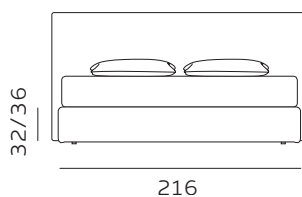

216
materasso largh. cm. 200
mattress width cm. 200

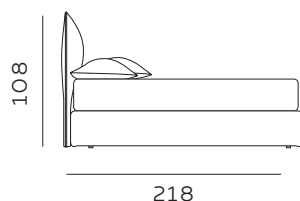

218
materasso lungh. cm. 200
mattress length cm. 200

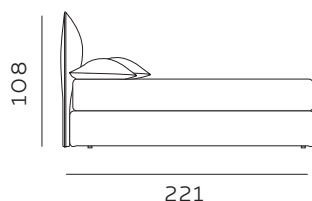

221
materasso lungh. cm. 203
mattress length cm. 203

H. 28 BOX CONTENITORE / BOX CONTENITORE EASY-UP STORAGE BOX / STORAGE BOX EASY-UP

Il box contenitore standard e box contenitore easy-up sono disponibili per giroletto standard e sagomato.
The standard storage box and easy-up storage box are available for both standard and shaped bed frames.

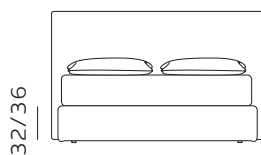

136

materasso largh. cm. 120
mattress width cm. 120

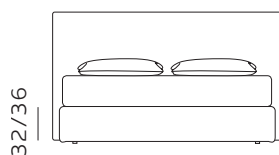

176

materasso largh. cm. 160
mattress width cm. 160

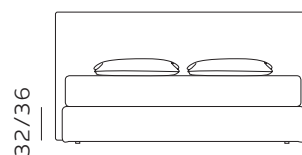

196

materasso largh. cm. 180
mattress width cm. 180

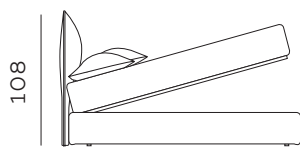

208

materasso largh. cm. 190
mattress length cm. 190

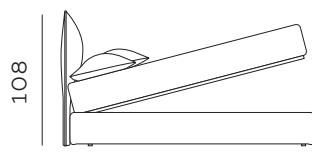

218

materasso largh. cm. 200
mattress length cm. 200

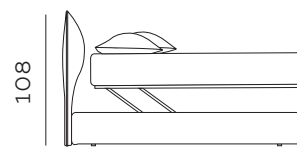

208

materasso largh. cm. 190
mattress length cm. 190

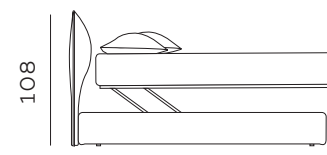

218

materasso largh. cm. 200
mattress length cm. 200

6

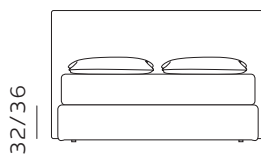

169

materasso largh. cm. 153
mattress width cm. 153

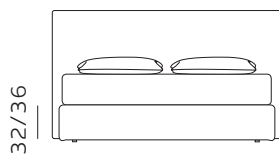

209

materasso largh. cm. 193
mattress width cm. 193

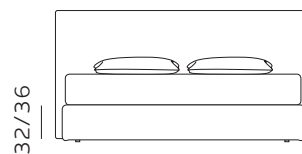

216

materasso largh. cm. 200
mattress width cm. 200

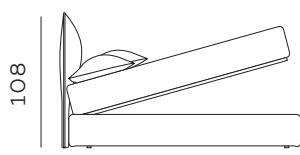

218

materasso largh. cm. 200
mattress length cm. 200

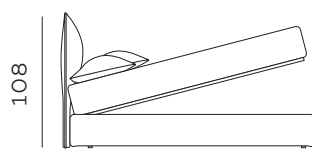

221

materasso largh. cm. 203
mattress length cm. 203

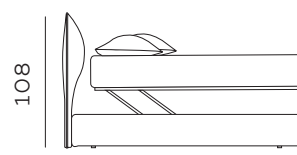

218

materasso largh. cm. 200
mattress length cm. 200

Per le misure Queen e King non è prevista la versione box contenitore easy-up. / The easy-up box storage version is not available for Queen and King sizes.

RETE DI SERIE per BOX CONTENITORE – Standard o Easy Up - Struttura tubolare in acciaio verniciato a polveri e piano rete doppia campata con 14 listelle in multistrato di faggio misura 68x8 mm. (68x12 mm. nella versione 120) - supporto doghe singolo fisso in nylon anticigolio. Per eventuali richieste di sostituzione della rete di serie con modello alternativo richiedere fattibilità e preventivo all'ufficio vendite. / STANDAR BASE for STORAGE BOX– Standard or Easy Up - Tubular structure in powder-coated steel and a double-span slatted base with 14 beech plywood slats measuring 68x8 mm. (68x12 mm. for the 120 version) - fixed single slat supports in anti-squeak nylon. For any requests to replace the standard base with an alternative model, please request feasibility and quotation from the sales department.

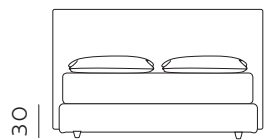

136

materasso largh. cm. 120
mattress width cm. 120

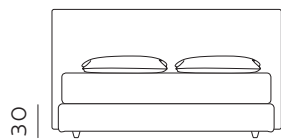

176

materasso largh. cm. 160
mattress width cm. 160

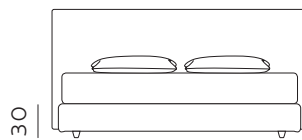

196

materasso largh. cm. 180
mattress width cm. 180

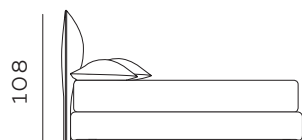

208

materasso lungh. cm. 190
mattress length cm. 190

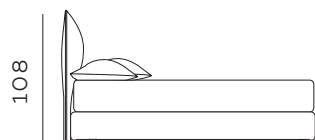

218

materasso lungh. cm. 200
mattress length cm. 200

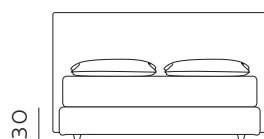

169

materasso largh. cm. 153
mattress width cm. 153

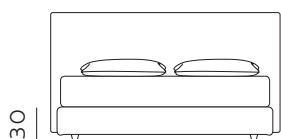

209

materasso largh. cm. 193
mattress width cm. 193

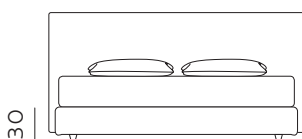

216

materasso largh. cm. 200
mattress width cm. 200

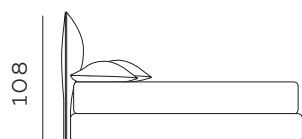

218

materasso lungh. cm. 200
mattress length cm. 200

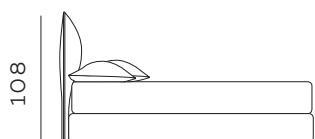

221

materasso lungh. cm. 203
mattress length cm. 203

H. 22 BOX CONTENITORE STORAGE BOX

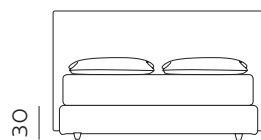

136

materasso largh. cm. 120
mattress width cm. 120

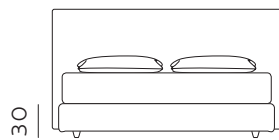

176

materasso largh. cm. 160
mattress width cm. 160

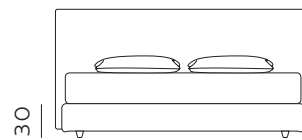

196

materasso largh. cm. 180
mattress width cm. 180

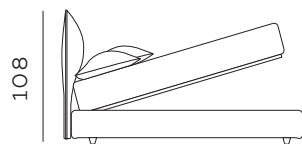

208

materasso lungh. cm. 190
mattress length cm. 190

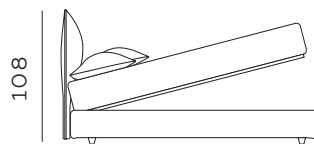

218

materasso lungh. cm. 200
mattress length cm. 200

8

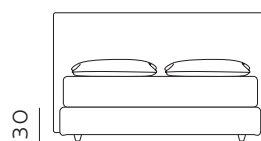

169

materasso largh. cm. 153
mattress width cm. 153

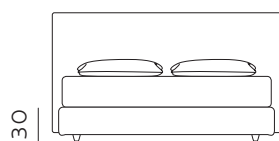

209

materasso largh. cm. 193
mattress width cm. 193

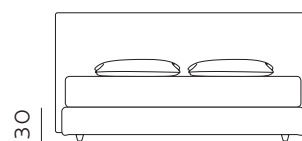

216

materasso largh. cm. 200
mattress width cm. 200

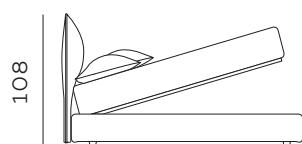

218

materasso lungh. cm. 200
mattress length cm. 200

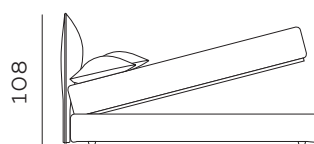

221

materasso lungh. cm. 203
mattress length cm. 203

RETE DI SERIE per BOX CONTENITORE – Standard o Easy Up – Struttura tubolare in acciaio verniciato a polveri e piano rete doppia campata con 14 listelle in multistrato di faggio misura 68x8 mm. (68x12 mm. nella versione 120) - supporto doghe singolo fisso in nylon anticigolio. Per eventuali richieste di sostituzione della rete di serie con modello alternativo richiedere fattibilità e preventivo all'ufficio vendite. / STANDAR BASE for STORAGE BOX– Standard or Easy Up - Tubular structure in powder-coated steel and a double-span slatted base with 14 beech plywood slats measuring 68x8 mm. (68x12 mm. for the 120 version) - fixed single slat supports in anti-squeak nylon. For any requests to replace the standard base with an alternative model, please request feasibility and quotation from the sales department.

PIEDINI PER GIROLETTO h. 22 e 28
FEET FOR BED FRAME h. 22 and 28

Sagomato h. 8 / Shaped h. 8



naturale
natural



wengé
wenge



nero laccato
lacquered black

**PIEDINO DI SERIE
 PER GIROLETTO h. 22
 STANDARD FEET
 FOR BED FRAME h. 22**

Conico h. 8 / Conical h. 8



nero laccato
lacquered black

**PIEDINO DI SERIE
 PER GIROLETTO h. 28
 STANDARD FEET
 FOR BED FRAME h. 28**

Cilindro h. 4 / Cylinder h. 4



nero laccato
lacquered black

Conico h. 8 / Conical h. 8



naturale
natural



rovere sbiancato
bleached oak



wengé
wenge



noce canaletto
canaletto walnut

Piramide h. 8 / Pyramid h. 8



naturale
natural



rovere sbiancato
bleached oak



wengé
wenge



nero laccato
lacquered black

Trapezio h. 8 / Trapezium h. 8



naturale
natural



nero laccato
lacquered black

Permette il passaggio del robot aspirapolvere
 It allows passage for the robot vacuum cleaner



In fase di ordine deve essere specificata la
 finitura del piedino laddove richiesto. / Please
 specify foot finish when ordering if required.

Istruzioni di montaggio, vedi pag. 120
 Assembly instructions, see page 120

Cartella tessuti, vedi pag 130
 Fabric samples, see page 130

Listino prezzi, vedi pag 04
 Price List, see page 04

ISABEL

Scheda tecnica / Technical data

Isabel è un letto imbottito e sfoderabile, realizzato in diverse dimensioni e disponibile in due diverse altezze di giroletto: 28 cm., anche in versione sagomata, con box standard o easy-up, 22 cm. disponibile anche con box contenitore. Il modello Isabel è personalizzabile con piedini dalle diverse tipologie e finiture: piedini di altezza 8 cm. e di serie di 4 cm. per il giroletto da 28 cm., piedini di altezza 8 cm. per il giroletto da 22 cm.

Isabel is an upholstered and removable bed, available in two bed frame heights: 28 cm., also in a shaped version, available with standard storage box and easy-up box system, and 22 cm., available with storage box. Available in different sizes. The Isabel model can be customized with feet of different types, height and finishes: 8 cm. feet and standard 4 cm. feet for the 28 cm. bed frame, 8 cm. feet for the 22 cm. bed frame.



Immagine in alto
testiera / giroletto: Valletta 04
piedini: conico nero laccato h. 8 cm.
Immagine in basso
testiera / giroletto: Arca 421
piedini: cilindro nero laccato h. 4 cm.

Image above
headboard / bed frame: Valletta 04
feet: black lacquered conical h. 8 cm.
Image below
headboard / bed frame: Arca 421
feet: black lacquered cylinder h. 4 cm.



igiene sicura sfoderabile
e lavabile / safe hygiene
removable and washable



10



DIMENSIONI DISPONIBILI / AVAILABLE SIZES

matrimoniale 160x190 / 160x200 cm.
matrimoniale xl 180x190 / 180x200 cm.
queen 153x203 cm.
king 193x203 cm.
matrimoniale xxl 200x200 cm.

*double bed 160x190 / 160x200 cm.
double bed xl 180x190 / 180x200 cm.
queen 153x203 cm.
king 193x203 cm.
double bed xxl 200x200 cm.*

H. 28 GIROLETTO / GIROLETTO SAGOMATO

BED FRAME / SHAPED BED FRAME

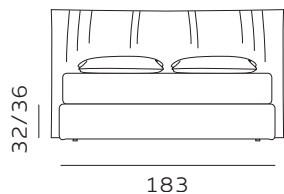

materasso largh. cm. 160
mattress width cm. 160

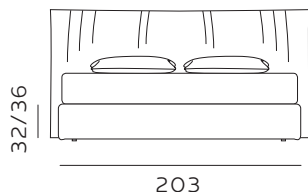

materasso largh. cm. 180
mattress width cm. 180

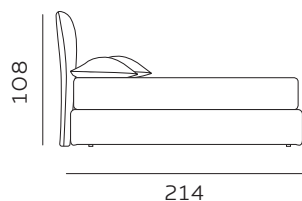

materasso lungh. cm. 190
mattress length cm. 190

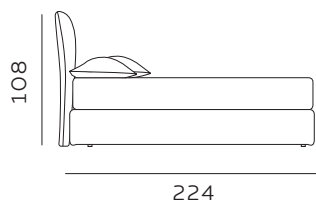

materasso lungh. cm. 200
mattress length cm. 200

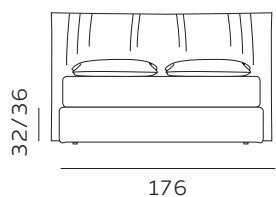

materasso largh. cm. 153
mattress width cm. 153

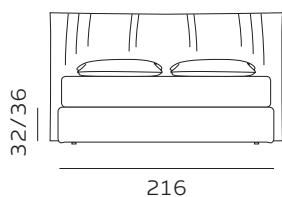

materasso largh. cm. 193
mattress width cm. 193

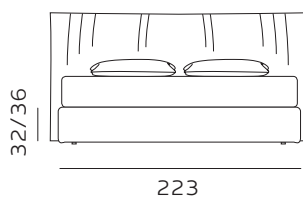

materasso largh. cm. 200
mattress width cm. 200

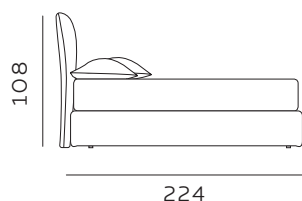

materasso lungh. cm. 200
mattress length cm. 200

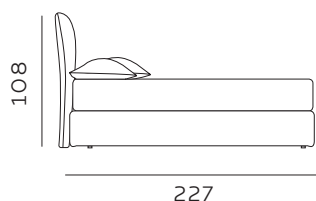

materasso lungh. cm. 203
mattress length cm. 203

H. 28 BOX CONTENITORE / BOX CONTENITORE EASY-UP STORAGE BOX / STORAGE BOX EASY-UP

Il box contenitore standard e box contenitore easy-up sono disponibili per giroletto standard e sagomato.
The standard storage box and easy-up storage box are available for both standard and shaped bed frames.

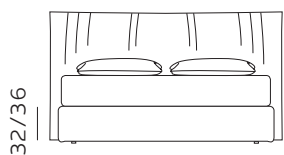

183

materasso largh. cm. 160
mattress width cm. 160

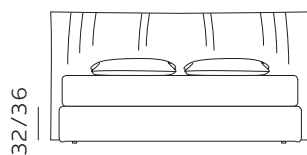

203

materasso largh. cm. 180
mattress width cm. 180

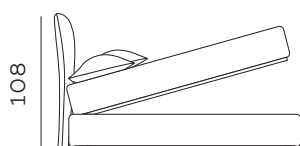

214

materasso lungh. cm. 190
mattress length cm. 190

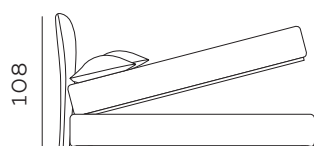

224

materasso lungh. cm. 200
mattress length cm. 200

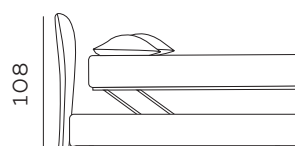

214

materasso lungh. cm. 190
mattress length cm. 190

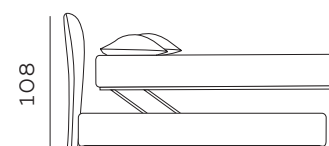

224

materasso lungh. cm. 200
mattress length cm. 200

12

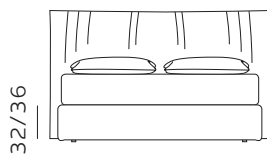

176

materasso largh. cm. 153
mattress width cm. 153

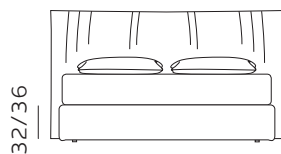

216

materasso largh. cm. 193
mattress width cm. 193

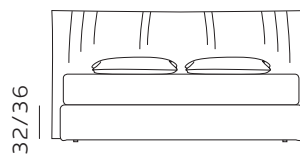

223

materasso largh. cm. 200
mattress width cm. 200

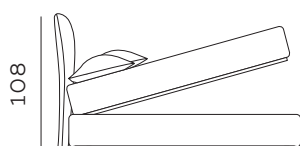

224

materasso lungh. cm. 200
mattress length cm. 200

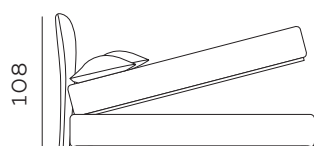

227

materasso lungh. cm. 203
mattress length cm. 203

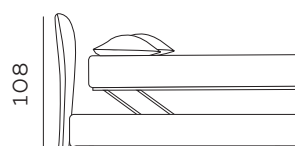

224

materasso lungh. cm. 200
mattress length cm. 200

Per le misure Queen e King non è prevista la versione box contenitore easy-up. / The easy-up box storage version is not available for Queen and King sizes.

RETE DI SERIE per BOX CONTENITORE – Standard o Easy Up - Struttura tubolare in acciaio verniciato a polveri e piano rete doppia campata con 14 listelle in multistrato di faggio misura 68x8 mm. (68x12 mm. nella versione 120) - supporto doghe singolo fisso in nylon anticigolio. Per eventuali richieste di sostituzione della rete di serie con modello alternativo richiedere fattibilità e preventivo all'ufficio vendite. / STANDAR BASE for STORAGE BOX– Standard or Easy Up - Tubular structure in powder-coated steel and a double-span slatted base with 14 beech plywood slats measuring 68x8 mm. (68x12 mm. for the 120 version) - fixed single slat supports in anti-squeak nylon. For any requests to replace the standard base with an alternative model, please request feasibility and quotation from the sales department.

H. 22 GIROLETTO BED FRAME

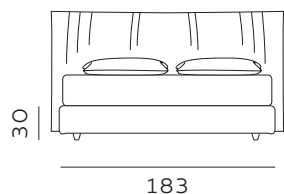

materasso largh. cm. 160
mattress width cm. 160

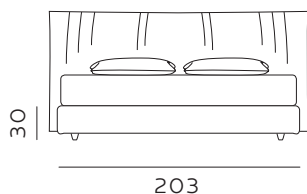

materasso largh. cm. 180
mattress width cm. 180

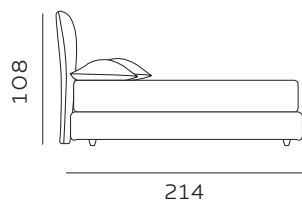

materasso lungh. cm. 190
mattress length cm. 190

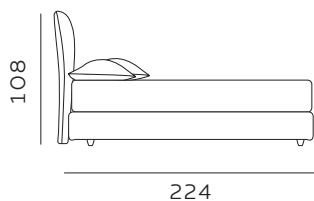

materasso lungh. cm. 200
mattress length cm. 200

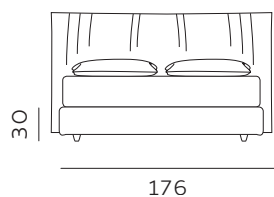

materasso largh. cm. 153
mattress width cm. 153

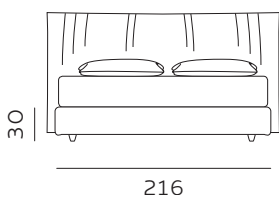

materasso largh. cm. 193
mattress width cm. 193

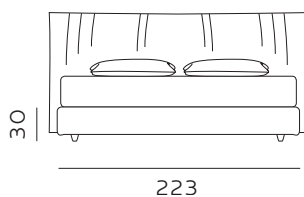

materasso largh. cm. 200
mattress width cm. 200

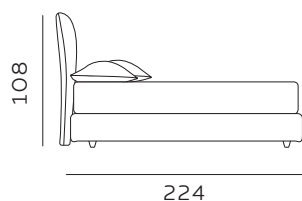

materasso lungh. cm. 200
mattress length cm. 200

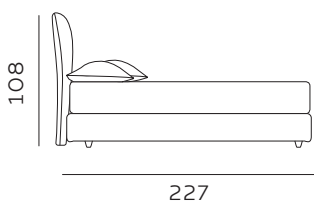

materasso lungh. cm. 203
mattress length cm. 203

H. 22 BOX CONTENITORE STORAGE BOX

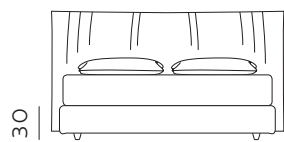

183

materasso largh. cm. 160
mattress width cm. 160

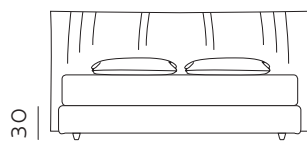

203

materasso largh. cm. 180
mattress width cm. 180

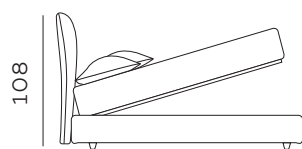

214

materasso lungh. cm. 190
mattress length cm. 190

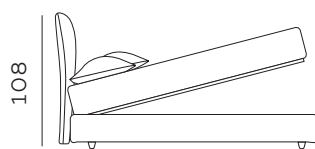

224

materasso lungh. cm. 200
mattress length cm. 200

14

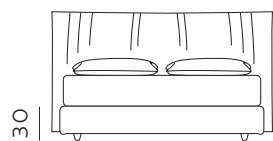

176

materasso largh. cm. 153
mattress width cm. 153

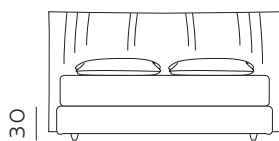

216

materasso largh. cm. 193
mattress width cm. 193

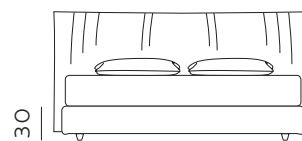

223

materasso largh. cm. 200
mattress width cm. 200

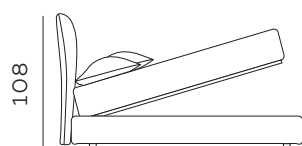

224

materasso lungh. cm. 200
mattress length cm. 200

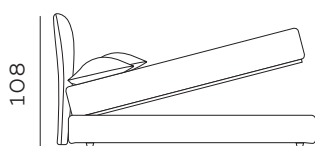

227

materasso lungh. cm. 203
mattress length cm. 203

RETE DI SERIE per BOX CONTENITORE – Standard o Easy Up – Struttura tubolare in acciaio verniciato a polveri e piano rete doppia campata con 14 listelle in multistrato di faggio misura 68x8 mm. (68x12 mm. nella versione 120) - supporto doghe singolo fisso in nylon anticigolio. Per eventuali richieste di sostituzione della rete di serie con modello alternativo richiedere fattibilità e preventivo all'ufficio vendite. / **STANDAR BASE for STORAGE BOX– Standard or Easy Up –** Tubular structure in powder-coated steel and a double-span slatted base with 14 beech plywood slats measuring 68x8 mm. (68x12 mm. for the 120 version) - fixed single slat supports in anti-squeak nylon. For any requests to replace the standard base with an alternative model, please request feasibility and quotation from the sales department.

PIEDINI PER GIROLETTO h. 22 e 28
FEET FOR BED FRAME h. 22 and 28

Sagomato h. 8 / Shaped h. 8



naturale
natural



wengé
wenge



nero laccato
lacquered black

**PIEDINO DI SERIE
 PER GIROLETTO h. 22
 STANDARD FEET
 FOR BED FRAME h. 22**

Conico h. 8 / Conical h. 8



nero laccato
lacquered black

**PIEDINO DI SERIE
 PER GIROLETTO h. 28
 STANDARD FEET
 FOR BED FRAME h. 28**

Cilindro h. 4 / Cylinder h. 4



nero laccato
lacquered black

Conico h. 8 / Conical h. 8



naturale
natural



rovere sbiancato
bleached oak



wengé
wenge



noce canaletto
canaletto walnut

Piramide h. 8 / Pyramid h. 8



naturale
natural



rovere sbiancato
bleached oak



wengé
wenge



nero laccato
lacquered black

Trapezio h. 8 / Trapezium h. 8



naturale
natural



nero laccato
lacquered black

Permette il passaggio del robot aspirapolvere
It allows passage for the robot vacuum cleaner



In fase di ordine deve essere specificata la
 finitura del piedino laddove richiesto. / *Please*
specify foot finish when ordering if required.

Istruzioni di montaggio, vedi pag. 120
Assembly instructions, see page 120

Cartella tessuti, vedi pag 130
Fabric samples, see page 130

Listino prezzi, vedi pag 08
Price List, see page 08

MATRIX*

Scheda tecnica / Technical data

Matrix è un letto imbottito e trapuntato con testiera non sfoderabile, realizzato in diverse dimensioni. Disponibile in due diverse altezze di giroletto, 28 cm., con box standard o in versione easy-up, 22 cm., realizzabile anche con box contenitore, il letto Matrix viene personalizzato con piedini dalle diverse tipologie e finiture: piedini di altezza 8 cm. e di serie di 4 cm. per il giroletto da 28 cm., piedini di altezza 8 cm. per il giroletto da 22 cm.

Matrix is an upholstered and quilted bed with a non-removable headboard, available in different sizes. It comes in two bed frame heights: 28 cm., available with standard storage box and easy-up box system, and 22 cm., available with storage box. Available in different sizes, Matrix can be customized with feet of different types, height and finishes: 8 cm. feet and standard 4 cm. feet for the 28 cm. bed frame, 8 cm. feet for the 22 cm. bed frame.



Immagine in alto
testiera / giroletto: Oviedo 13
piedini: cilindro nero laccato h. 4 cm.
Immagine in basso
testiera / giroletto: Miami 26
piedini: conico naturale h. 8 cm.

Image above
headboard / bed frame: Oviedo 13
feet: black lacquered cylinder h. 4 cm.
Image below
headboard / bed frame: Miami 26
feet: natural conical h. 8 cm.



igiene sicura sfoderabile
e lavabile per giroletto/
safe hygiene removable
and washable for bed
frame



16



DIMENSIONI DISPONIBILI / AVAILABLE SIZES

piazza e mezza 120x190 / 120x200 cm.
matrimoniale 160x190 / 160x200 cm.
matrimoniale xl 180x190 / 180x200 cm.
queen 153x203 cm.

three-quarter size 120x190 / 120x200 cm.
double bed 160x190 / 160x200 cm.
double bed xl 180x190 / 180x200 cm.
queen 153x203 cm.

H. 28 GIROLETTO BED FRAME

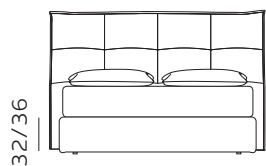

147

materasso largh. cm. 120
mattress width cm. 120

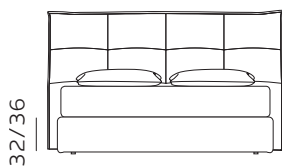

187

materasso largh. cm. 160
mattress width cm. 160

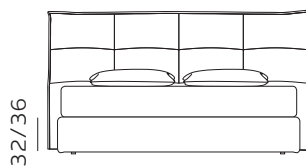

207

materasso largh. cm. 180
mattress width cm. 180

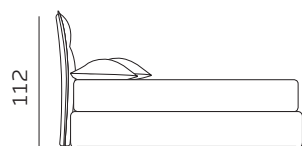

217

materasso lungh. cm. 190
mattress length cm. 190

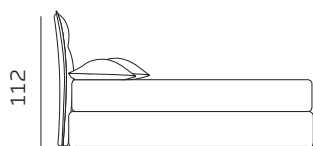

227

materasso lungh. cm. 200
mattress length cm. 200

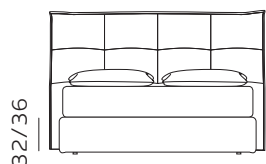

180

materasso largh. cm. 153
mattress width cm. 153

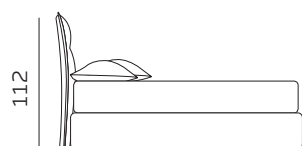

230

materasso lungh. cm. 203
mattress length cm. 203

H. 28 BOX CONTENITORE / BOX CONTENITORE EASY-UP STORAGE BOX / STORAGE BOX EASY-UP

Il box contenitore standard e box contenitore easy-up sono disponibili per giroletto standard e sagomato.
The standard storage box and easy-up storage box are available for both standard and shaped bed frames.

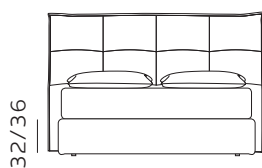

147

materasso largh. cm. 120
mattress width cm. 120

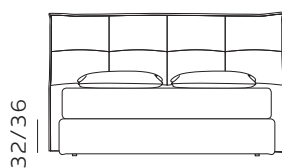

187

materasso largh. cm. 160
mattress width cm. 160

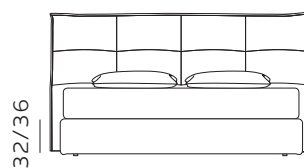

207

materasso largh. cm. 180
mattress width cm. 180

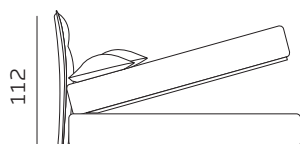

217

materasso lungh. cm. 190
mattress length cm. 190

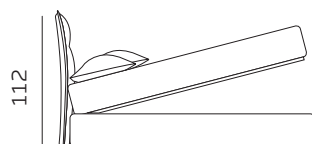

227

materasso lungh. cm. 200
mattress length cm. 200

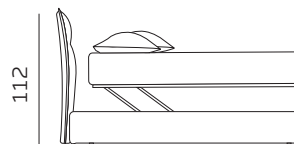

217

materasso lungh. cm. 190
mattress length cm. 190

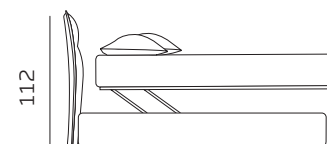

227

materasso lungh. cm. 200
mattress length cm. 200

18

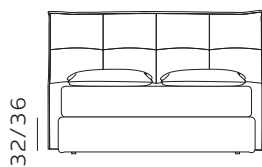

180

materasso largh. cm. 153
mattress width cm. 153

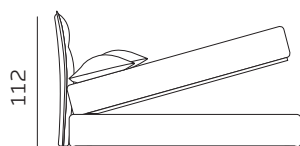

230

materasso lungh. cm. 203
mattress length cm. 203

Per le misure Queen e King non è prevista la versione box contenitore easy-up. / The easy-up box storage version is not available for Queen and King sizes.

RETE DI SERIE per BOX CONTENITORE – Standard o Easy Up - Struttura tubolare in acciaio verniciato a polveri e piano rete doppia campata con 14 listelle in multistrato di faggio misura 68x8 mm. (68x12 mm. nella versione 120) - supporto doghe singolo fisso in nylon anticigolio. Per eventuali richieste di sostituzione della rete di serie con modello alternativo richiedere fattibilità e preventivo all'ufficio vendite. / STANDAR BASE for STORAGE BOX– Standard or Easy Up - Tubular structure in powder-coated steel and a double-span slatted base with 14 beech plywood slats measuring 68x8 mm. (68x12 mm. for the 120 version) - fixed single slat supports in anti-squeak nylon. For any requests to replace the standard base with an alternative model, please request feasibility and quotation from the sales department.

H. 22 GIROLETTO BED FRAME

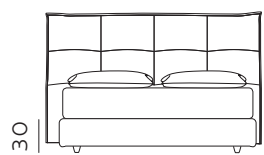

147

materasso largh. cm. 120
mattress width cm. 120

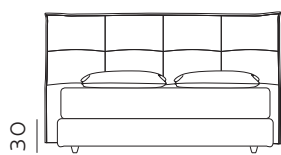

187

materasso largh. cm. 160
mattress width cm. 160

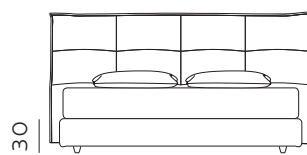

207

materasso largh. cm. 180
mattress width cm. 180

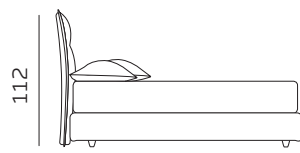

217

materasso lungh. cm. 190
mattress length cm. 190

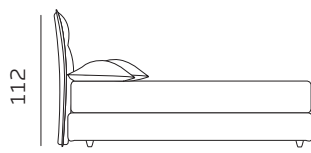

227

materasso lungh. cm. 200
mattress length cm. 200

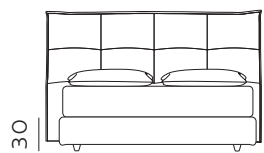

180

materasso largh. cm. 153
mattress width cm. 153

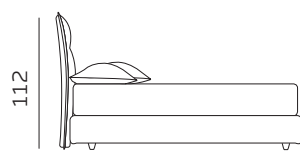

230

materasso lungh. cm. 203
mattress length cm. 203

H. 22 BOX CONTENITORE STORAGE BOX

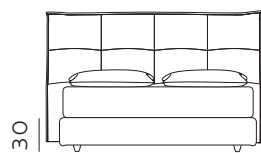

147

materasso largh. cm. 120
mattress width cm. 120

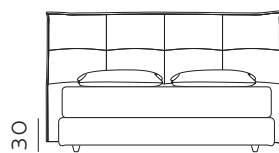

187

materasso largh. cm. 160
mattress width cm. 160

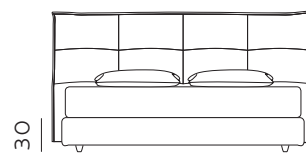

207

materasso largh. cm. 180
mattress width cm. 180

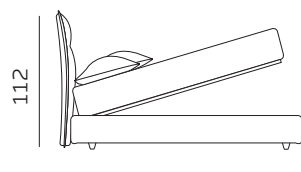

217

materasso lungh. cm. 190
mattress length cm. 190

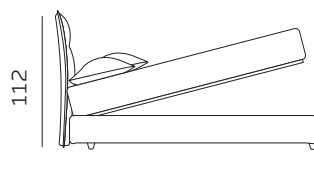

227

materasso lungh. cm. 200
mattress length cm. 200

20

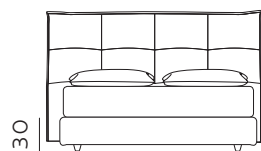

180

materasso largh. cm. 153
mattress width cm. 153

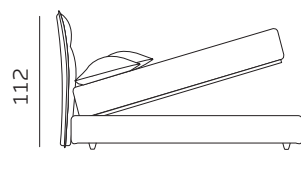

230

materasso lungh. cm. 203
mattress length cm. 203

RETE DI SERIE per BOX CONTENITORE – Standard o Easy Up – Struttura tubolare in acciaio verniciato a polveri e piano rete doppia campata con 14 listelle in multistrato di faggio misura 68x8 mm. (68x12 mm. nella versione 120) - supporto doghe singolo fisso in nylon anticigolio. Per eventuali richieste di sostituzione della rete di serie con modello alternativo richiedere fattibilità e preventivo all'ufficio vendite. / STANDAR BASE for STORAGE BOX– Standard or Easy Up - Tubular structure in powder-coated steel and a double-span slatted base with 14 beech plywood slats measuring 68x8 mm. (68x12 mm. for the 120 version) - fixed single slat supports in anti-squeak nylon. For any requests to replace the standard base with an alternative model, please request feasibility and quotation from the sales department.

PIEDINI PER GIROLETTO h. 22 e 28
FEET FOR BED FRAME h. 22 and 28

Sagomato h. 8 / Shaped h. 8



naturale
natural



wengé
wenge



nero laccato
lacquered black

PIEDINO DI SERIE
PER GIROLETTO h. 22
STANDARD FEET
FOR BED FRAME h. 22

Conico h. 8 / Conical h. 8



nero laccato
lacquered black

PIEDINO DI SERIE
PER GIROLETTO h. 28
STANDARD FEET
FOR BED FRAME h. 28

Cilindro h. 4 / Cylinder h. 4



nero laccato
lacquered black

Conico h. 8 / Conical h. 8



naturale
natural



rovere sbiancato
bleached oak



wengé
wenge



noce canaletto
canaletto walnut

Piramide h. 8 / Pyramid h. 8



naturale
natural



rovere sbiancato
bleached oak



wengé
wenge



nero laccato
lacquered black

Trapezio h. 8 / Trapezium h. 8



naturale
natural



nero laccato
lacquered black

Permette il passaggio del robot aspirapolvere
It allows passage for the robot vacuum cleaner



In fase di ordine deve essere specificata la
finitura del piedino laddove richiesto. / Please
specify foot finish when ordering if required.

Istruzioni di montaggio, vedi pag. 120
Assembly instructions, see page 120

Cartella tessuti, vedi pag 130
Fabric samples, see page 130

Listino prezzi, vedi pag 12
Price List, see page 12

FOLDER

Scheda tecnica / Technical data

Il letto Folder è un letto imbottito sfoderabile disponibile in diverse misure e realizzabile in due altezze di giroletto: 28 cm., anche in versione sagomato, sia con box standard che con sistema easy-up, e 22 cm., anche con box contenitore. Questo modello può essere personalizzato con piedini dalle diverse tipologie e finiture: di altezza 8 cm. e di serie di 4 cm. per il giroletto da 28 cm., piedini di altezza 8 cm. per il giroletto da 22 cm.

The Folder bed is an upholstered, removable bed available in different sizes. It has two bed frame heights: 28 cm., also in a shaped version, available with standard storage box and easy-up box system, and 22 cm., available with storage box. This model can be customized with feet of different types, height and finishes: 8 cm. feet and standard 4 cm. feet for the 28 cm. bed frame, 8 cm. feet for the 22 cm. bed frame.



Immagine in alto
testiera / giroletto: Solemio 107
piedini: cilindro nero laccato h. 4 cm.
Immagine in basso
testiera / giroletto: Salice O3
piedini: conico nero laccato h. 8 cm.

Image above
headboard / bed frame: Solemio 107
feet: black lacquered cylinder h. 4 cm.
Image below
headboard / bed frame: Salice O3
feet: black lacquered conical h. 8 cm.



igiene sicura sfoderabile
e lavabile / safe hygiene
removable and washable



22

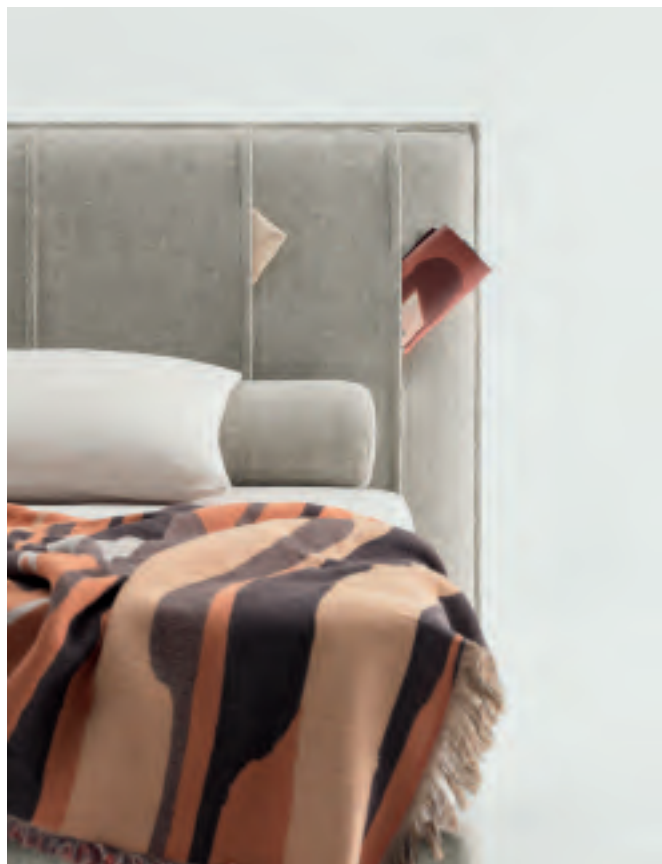

DIMENSIONI DISPONIBILI / AVAILABLE SIZES

piazza e mezza 120x190 / 120x200 cm.
matrimoniale 160x190 / 160x200 cm.
matrimoniale xl 180x190 / 180x200 cm.
queen 153x203 cm.
king 193x203 cm.
matrimoniale xxl 200x200 cm.

*three-quarter size 120x190 / 120x200 cm.
double bed 160x190 / 160x200 cm.
double bed xl 180x190 / 180x200 cm.
queen 153x203 cm.
king 193x203 cm.
double bed xxl 200x200 cm.*

H. 28 GIROLETTO / GIROLETTO SAGOMATO

BED FRAME / SHAPED BED FRAME

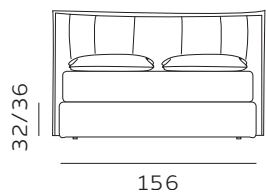

156
materasso largh. cm. 120
mattress width cm. 120

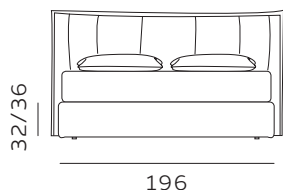

196
materasso largh. cm. 160
mattress width cm. 160

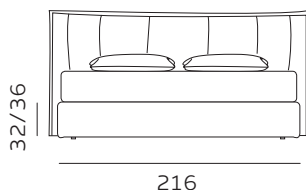

216
materasso largh. cm. 180
mattress width cm. 180

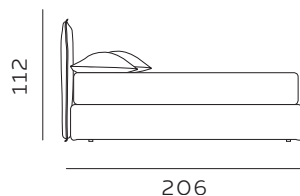

206
materasso lungh. cm. 190
mattress length cm. 190

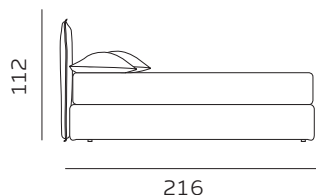

216
materasso lungh. cm. 200
mattress length cm. 200

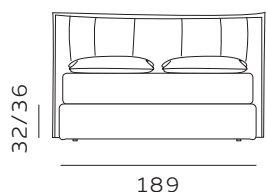

189
materasso largh. cm. 153
mattress width cm. 153

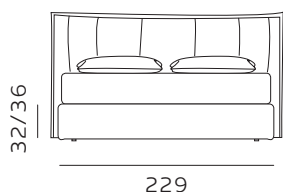

229
materasso largh. cm. 193
mattress width cm. 193

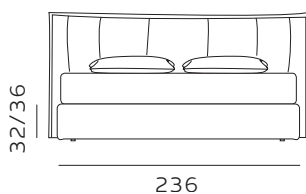

236
materasso largh. cm. 200
mattress width cm. 200

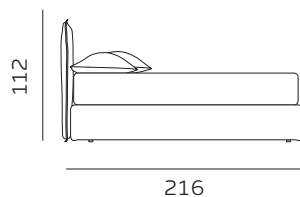

216
materasso lungh. cm. 200
mattress length cm. 200

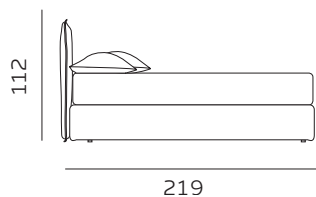

219
materasso lungh. cm. 203
mattress length cm. 203

H. 28 BOX CONTENITORE / BOX CONTENITORE EASY-UP STORAGE BOX / STORAGE BOX EASY-UP

Il box contenitore standard e box contenitore easy-up sono disponibili per giroletto standard e sagomato.
The standard storage box and easy-up storage box are available for both standard and shaped bed frames.

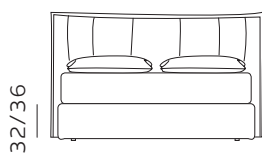

156

materasso largh. cm. 120
mattress width cm. 120

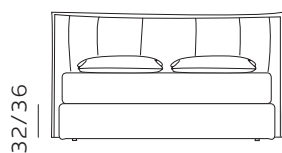

196

materasso largh. cm. 160
mattress width cm. 160

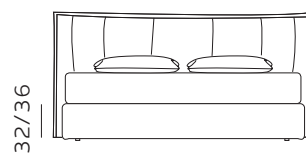

216

materasso largh. cm. 180
mattress width cm. 180

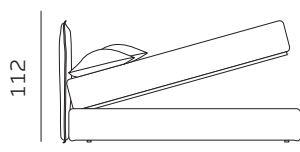

206

materasso lungh. cm. 190
mattress length cm. 190

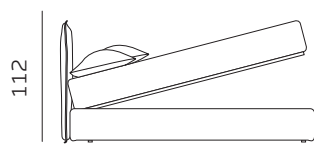

216

materasso lungh. cm. 200
mattress length cm. 200

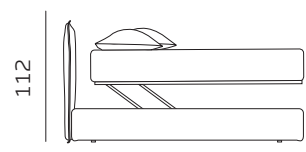

206

materasso lungh. cm. 190
mattress length cm. 190

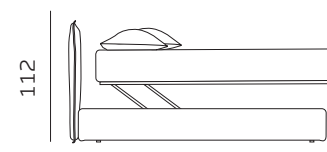

216

materasso lungh. cm. 200
mattress length cm. 200

24

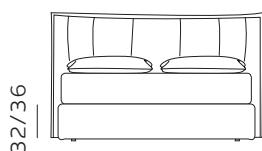

189

materasso largh. cm. 153
mattress width cm. 153

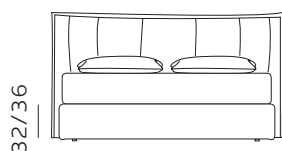

229

materasso largh. cm. 193
mattress width cm. 193

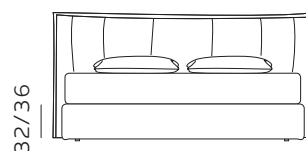

236

materasso largh. cm. 200
mattress width cm. 200

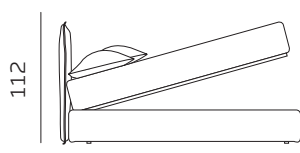

216

materasso lungh. cm. 200
mattress length cm. 200

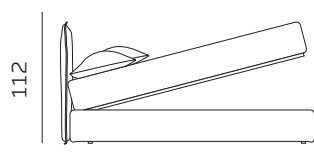

219

materasso lungh. cm. 203
mattress length cm. 203

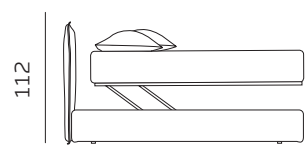

216

materasso lungh. cm. 200
mattress length cm. 200

Per le misure Queen e King non è prevista la versione box contenitore easy-up. / The easy-up box storage version is not available for Queen and King sizes.

RETE DI SERIE per BOX CONTENITORE – Standard o Easy Up - Struttura tubolare in acciaio verniciato a polveri e piano rete doppia campata con 14 listelle in multistrato di faggio misura 68x8 mm. (68x12 mm. nella versione 120) - supporto doghe singolo fisso in nylon anticigolio. Per eventuali richieste di sostituzione della rete di serie con modello alternativo richiedere fattibilità e preventivo all'ufficio vendite. / STANDAR BASE for STORAGE BOX– Standard or Easy Up - Tubular structure in powder-coated steel and a double-span slatted base with 14 beech plywood slats measuring 68x8 mm. (68x12 mm. for the 120 version) - fixed single slat supports in anti-squeak nylon. For any requests to replace the standard base with an alternative model, please request feasibility and quotation from the sales department.

H. 22 GIROLETTO BED FRAME

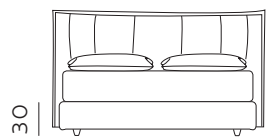

156

materasso largh. cm. 120
mattress width cm. 120

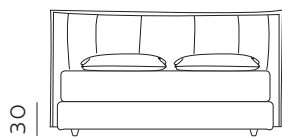

196

materasso largh. cm. 160
mattress width cm. 160

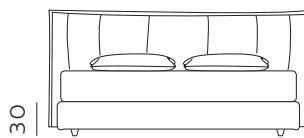

216

materasso largh. cm. 180
mattress width cm. 180

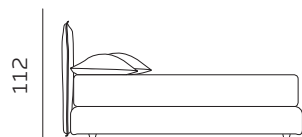

206

materasso lungh. cm. 190
mattress length cm. 190

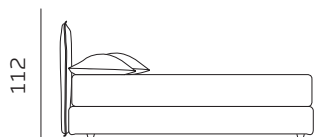

216

materasso lungh. cm. 200
mattress length cm. 200

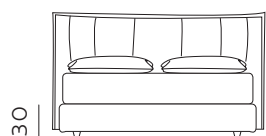

189

materasso largh. cm. 153
mattress width cm. 153

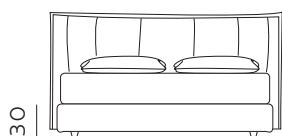

229

materasso largh. cm. 193
mattress width cm. 193

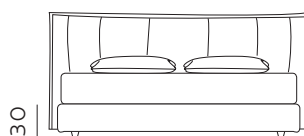

236

materasso largh. cm. 200
mattress width cm. 200

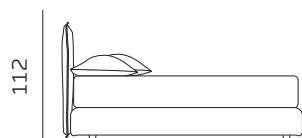

216

materasso lungh. cm. 200
mattress length cm. 200

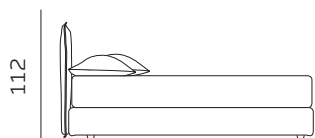

219

materasso lungh. cm. 203
mattress length cm. 203

H. 22 BOX CONTENITORE STORAGE BOX

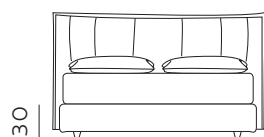

156

materasso largh. cm. 120
mattress width cm. 120

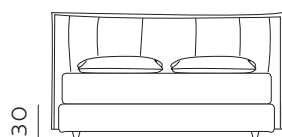

196

materasso largh. cm. 160
mattress width cm. 160

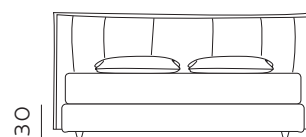

216

materasso largh. cm. 180
mattress width cm. 180

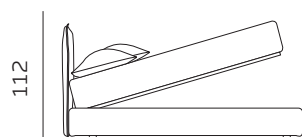

206

materasso lungh. cm. 190
mattress length cm. 190

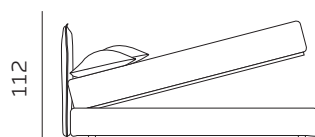

216

materasso lungh. cm. 200
mattress length cm. 200

26

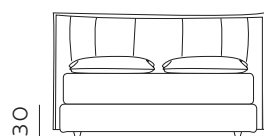

189

materasso largh. cm. 153
mattress width cm. 153

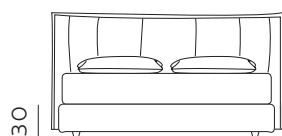

229

materasso largh. cm. 193
mattress width cm. 193

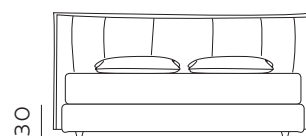

236

materasso largh. cm. 200
mattress width cm. 200

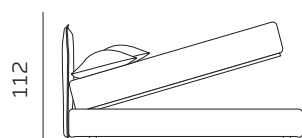

216

materasso lungh. cm. 200
mattress length cm. 200

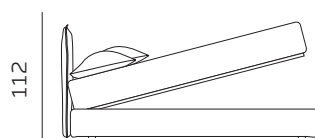

219

materasso lungh. cm. 203
mattress length cm. 203

RETE DI SERIE per BOX CONTENITORE – Standard o Easy Up – Struttura tubolare in acciaio verniciato a polveri e piano rete doppia campata con 14 listelle in multistrato di faggio misura 68x8 mm. (68x12 mm. nella versione 120) - supporto doghe singolo fisso in nylon anticigolio. Per eventuali richieste di sostituzione della rete di serie con modello alternativo richiedere fattibilità e preventivo all'ufficio vendite. / STANDAR BASE for STORAGE BOX– Standard or Easy Up - Tubular structure in powder-coated steel and a double-span slatted base with 14 beech plywood slats measuring 68x8 mm. (68x12 mm. for the 120 version) - fixed single slat supports in anti-squeak nylon. For any requests to replace the standard base with an alternative model, please request feasibility and quotation from the sales department.

PIEDINI PER GIROLETTO h. 22 e 28
FEET FOR BED FRAME h. 22 and 28

Sagomato h. 8 / Shaped h. 8



naturale
natural



wengé
wenge



nero laccato
lacquered black

PIEDINO DI SERIE
PER GIROLETTO h. 22
STANDARD FEET
FOR BED FRAME h. 22

Conico h. 8 / Conical h. 8



nero laccato
lacquered black

PIEDINO DI SERIE
PER GIROLETTO h. 28
STANDARD FEET
FOR BED FRAME h. 28

Cilindro h. 4 / Cylinder h. 4



nero laccato
lacquered black

Conico h. 8 / Conical h. 8



naturale
natural



rovere sbiancato
bleached oak



wengé
wenge



noce canaletto
canaletto walnut

Piramide h. 8 / Pyramid h. 8



naturale
natural



rovere sbiancato
bleached oak



wengé
wenge



nero laccato
lacquered black

Trapezio h. 8 / Trapezium h. 8



naturale
natural



nero laccato
lacquered black

Permette il passaggio del robot aspirapolvere
It allows passage for the robot vacuum cleaner



In fase di ordine deve essere specificata la
finitura del piedino laddove richiesto. / Please
specify foot finish when ordering if required.

Istruzioni di montaggio, vedi pag. 120
Assembly instructions, see page 120

Cartella tessuti, vedi pag 130
Fabric samples, see page 130

Listino prezzi, vedi pag 16
Price List, see page 16

HORIZON*

Scheda tecnica / Technical data

Horizon è un letto imbottito sfoderabile disponibile in diverse dimensioni. Questo modello può essere realizzato nelle due altezze di giroletto: la prima di 28 cm., realizzabile anche con giroletto sagomato, disponibile con box standard o easy-up, la seconda di 22 cm., disponibile anche con box contenitore. Viene personalizzato con piedini dalle diverse tipologie e finiture: piedini di altezza 8 cm. e di serie di 4 cm. per il giroletto da 28 cm., piedini di altezza 8 cm. per il giroletto da 22 cm.

Horizon is an upholstered, removable bed available in various sizes. This style can be made with two bed frame heights: 28 cm., also in a shaped version, available with standard storage box and easy-up box system, and 22 cm., available with storage box. This model can be customized with feet of different types, height and finishes: 8 cm. feet and standard 4 cm. feet for the 28 cm. bed frame, 8 cm. feet for the 22 cm. bed frame.



igiene sicura sfoderabile
e lavabile / safe hygiene
removable and washable



Immagine in alto
testiera / giroletto: Pinò 902
cucitura: col. 2196
piedini: cilindro nero laccato h. 4 cm.
Immagine in basso
testiera / giroletto: Toledo 74
cucitura: col. 5087
piedini: conico wengè h. 8 cm.

*Image above
headboard / bed frame: Pinò 902
stitching: col. 2196
feet: black lacquered cylinder h. 4 cm.
Image below
headboard / bed frame: Toledo 74
stitching: col. 5087
feet: wenge conical h. 8 cm.*

28



Per la scelta del bordino e della cucitura a contrasto consultare le varianti colore disponibili nelle due cartelle denominate FINITURE DETTAGLI presenti nel campionario tessuti collezione letti.

For the selection of the edging and contrasting stitching, please refer to the available color variants in the two folders named FINISHING DETAILS located in the fabric sample collection for beds.

DIMENSIONI DISPONIBILI / AVAILABLE SIZES

matrimoniale 160x190 / 160x200 cm.
matrimoniale xl 180x190 / 180x200 cm.
queen 153x203 cm.

*double bed 160x190 / 160x200 cm.
double bed xl 180x190 / 180x200 cm.
queen 153x203 cm.*

H. 28

GIROLETTO / GIROLETTO SAGOMATO
BED FRAME / SHAPED BED FRAME

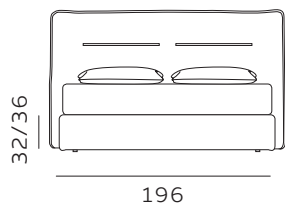

materasso largh. cm. 160
mattress width cm. 160

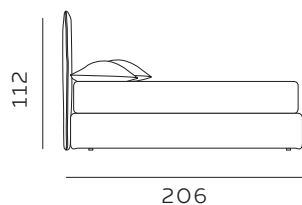

materasso lungh. cm. 190
mattress length cm. 190

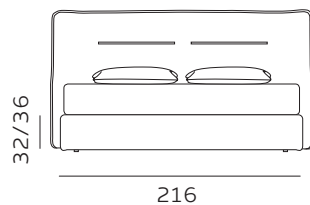

materasso largh. cm. 180
mattress width cm. 180

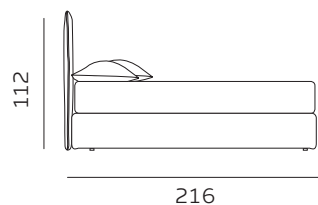

materasso lungh. cm. 200
mattress length cm. 200

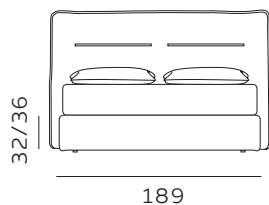

materasso largh. cm. 153
mattress width cm. 153

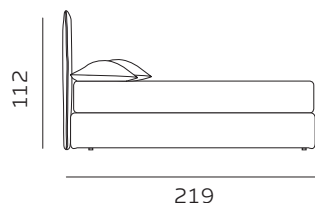

materasso lungh. cm. 203
mattress length cm. 203

H. 28 BOX CONTENITORE / BOX CONTENITORE EASY-UP STORAGE BOX / STORAGE BOX EASY-UP

Il box contenitore standard e box contenitore easy-up sono disponibili per giroletto standard e sagomato.
The standard storage box and easy-up storage box are available for both standard and shaped bed frames.

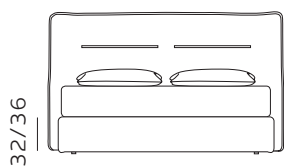

196
materasso largh. cm. 160
mattress width cm. 160

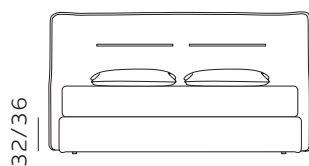

216
materasso largh. cm. 180
mattress width cm. 180

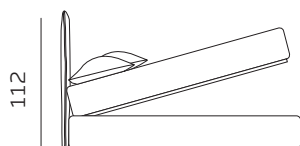

206
materasso lungh. cm. 190
mattress length cm. 190

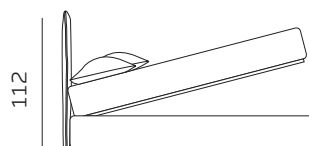

216
materasso lungh. cm. 200
mattress length cm. 200

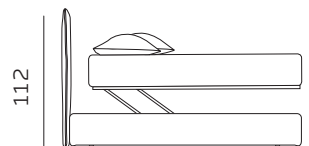

206
materasso lungh. cm. 190
mattress length cm. 190

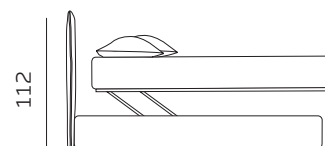

216
materasso lungh. cm. 200
mattress length cm. 200

30

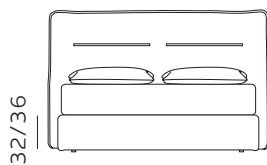

189
materasso largh. cm. 153
mattress width cm. 153

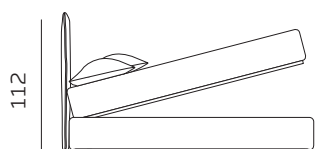

219
materasso lungh. cm. 203
mattress length cm. 203

Per le misure Queen e King non è prevista la versione box contenitore easy-up. / The easy-up box storage version is not available for Queen and King sizes.

RETE DI SERIE per BOX CONTENITORE – Standard o Easy Up - Struttura tubolare in acciaio verniciato a polveri e piano rete doppia campata con 14 listelle in multistrato di faggio misura 68x8 mm. (68x12 mm. nella versione 120) - supporto doghe singolo fisso in nylon anticigolio. Per eventuali richieste di sostituzione della rete di serie con modello alternativo richiedere fattibilità e preventivo all'ufficio vendite. / STANDAR BASE for STORAGE BOX– Standard or Easy Up - Tubular structure in powder-coated steel and a double-span slatted base with 14 beech plywood slats measuring 68x8 mm. (68x12 mm. for the 120 version) - fixed single slat supports in anti-squeak nylon. For any requests to replace the standard base with an alternative model, please request feasibility and quotation from the sales department.

H. 22 GIROLETTO BED FRAME

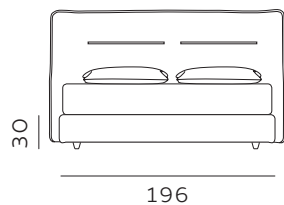

materasso largh. cm. 160
mattress width cm. 160

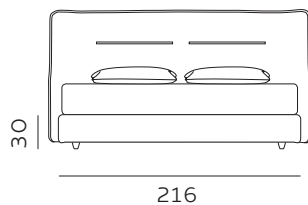

materasso largh. cm. 180
mattress width cm. 180

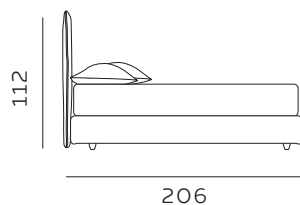

materasso lungh. cm. 190
mattress length cm. 190

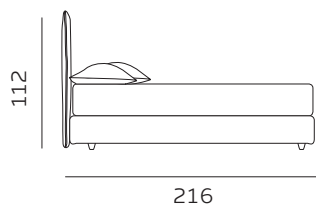

materasso lungh. cm. 200
mattress length cm. 200

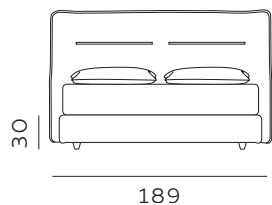

materasso largh. cm. 153
mattress width cm. 153

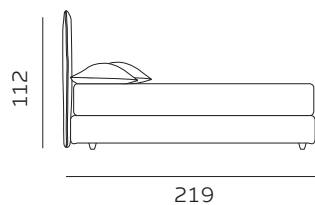

materasso lungh. cm. 203
mattress length cm. 203

H. 22 BOX CONTENITORE STORAGE BOX

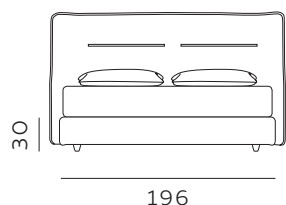

materasso largh. cm. 160
mattress width cm. 160

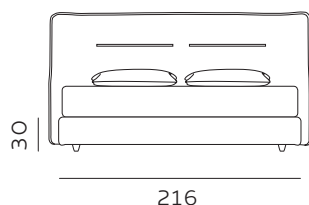

materasso largh. cm. 180
mattress width cm. 180

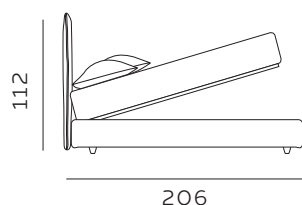

materasso lungh. cm. 190
mattress length cm. 190

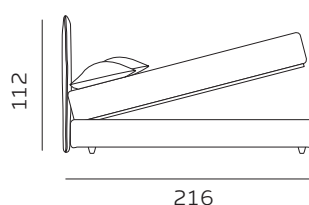

materasso lungh. cm. 200
mattress length cm. 200

32

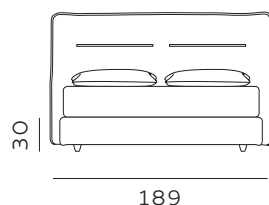

materasso largh. cm. 153
mattress width cm. 153

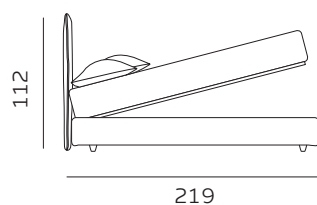

materasso lungh. cm. 203
mattress length cm. 203

RETE DI SERIE per BOX CONTENITORE – Standard o Easy Up – Struttura tubolare in acciaio verniciato a polveri e piano rete doppia campata con 14 listelle in multistrato di faggio misura 68x8 mm. (68x12 mm. nella versione 120) - supporto doghe singolo fisso in nylon anticigolio. Per eventuali richieste di sostituzione della rete di serie con modello alternativo richiedere fattibilità e preventivo all'ufficio vendite. / STANDAR BASE for STORAGE BOX– Standard or Easy Up - Tubular structure in powder-coated steel and a double-span slatted base with 14 beech plywood slats measuring 68x8 mm. (68x12 mm. for the 120 version) - fixed single slat supports in anti-squeak nylon. For any requests to replace the standard base with an alternative model, please request feasibility and quotation from the sales department.

PIEDINI PER GIROLETTO h. 22 e 28
FEET FOR BED FRAME h. 22 and 28

Sagomato h. 8 / Shaped h. 8



naturale
natural



wengé
wenge



nero laccato
lacquered black

**PIEDINO DI SERIE
PER GIROLETTO h. 22**
*STANDARD FEET
FOR BED FRAME h. 22*

Conico h. 8 / Conical h. 8



nero laccato
lacquered black

**PIEDINO DI SERIE
PER GIROLETTO h. 28**
*STANDARD FEET
FOR BED FRAME h. 28*

Cilindro h. 4 / Cylinder h. 4



nero laccato
lacquered black

Conico h. 8 / Conical h. 8



naturale
natural



rovere sbiancato
bleached oak



wengé
wenge



noce canaletto
canaletto walnut

Piramide h. 8 / Pyramid h. 8



naturale
natural



rovere sbiancato
bleached oak



wengé
wenge



nero laccato
lacquered black

Trapezio h. 8 / Trapezium h. 8



naturale
natural



nero laccato
lacquered black

Permette il passaggio del robot aspirapolvere
It allows passage for the robot vacuum cleaner



In fase di ordine deve essere specificata la
finitura del piedino laddove richiesto. / *Please*
specify foot finish when ordering if required.

Istruzioni di montaggio, vedi pag. 120
Assembly instructions, see page 120

Cartella tessuti, vedi pag 130
Fabric samples, see page 130

Listino prezzi, vedi pag 20
Price List, see page 20

BALTIMORA

Scheda tecnica / Technical data

Baltimora è un letto imbottito con testiera non sfoderabile disponibile in varie dimensioni e realizzato in due diverse altezze di giroletto: 28 cm. realizzabile anche con giroletto sagomato, con box standard o versione easy-up, e 22 cm. anche con box contenitore. Questo modello viene personalizzato con piedini dalle diverse tipologie e finiture: di altezza 8 cm. e di serie di 4 cm. per il giroletto da 28 cm., piedini di altezza 8 cm. per il giroletto da 22 cm.

Baltimora is an upholstered bed with non-removable headboard, available in different sizes. It comes in two different bed frame heights: 28 cm., also in a shaped version, available with standard storage box and easy-up box system, and 22 cm., available with storage box. This model can be customized with feet of different types, height and finishes: 8 cm. feet and standard 4 cm. feet for the 28 cm. bed frame, 8 cm. feet for the 22 cm. bed frame.



Immagine in alto
testiera / giroletto: Toledo 48
piedini: conico naturale h. 8 cm.
Immagine in basso
testiera / giroletto: Canvas White
piedini: cilindro nero laccato h. 4 cm.

34

*Image above
headboard / bed frame: Toledo 48
feet: natural conical h. 8 cm.
Image below
headboard / bed frame: Canvas White
feet: black lacquered cylinder h. 4 cm.*



igiene sicura sfoderabile
e lavabile per giroletto/
safe hygiene removable
and washable for bed
frame



DIMENSIONI DISPONIBILI / AVAILABLE SIZES

matrimoniale 160x190 / 160x200 cm.
matrimoniale xl 180x190 / 180x200 cm.
queen 153x203 cm.

*double bed 160x190 / 160x200 cm.
double bed xl 180x190 / 180x200 cm.
queen 153x203 cm.*

H. 28 GIROLETTO / GIROLETTO SAGOMATO

BED FRAME / SHAPED BED FRAME

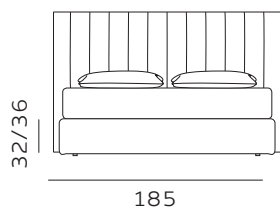

materasso largh. cm. 160
mattress width cm. 160

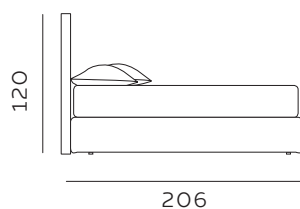

materasso lungh. cm. 190
mattress length cm. 190

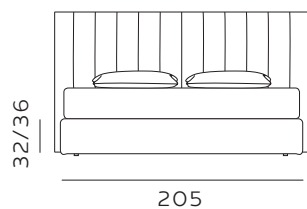

materasso largh. cm. 180
mattress width cm. 180

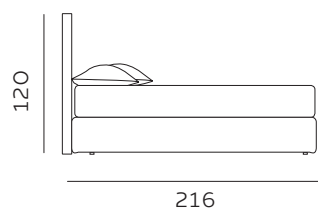

materasso lungh. cm. 200
mattress length cm. 200

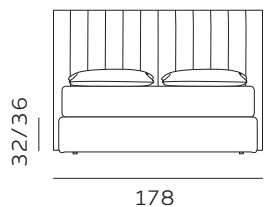

materasso largh. cm. 153
mattress width cm. 153

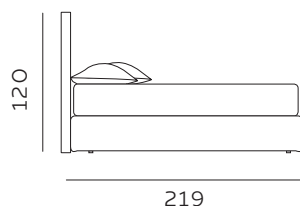

materasso lungh. cm. 203
mattress length cm. 203

H. 28 BOX CONTENITORE / BOX CONTENITORE EASY-UP STORAGE BOX / STORAGE BOX EASY-UP

Il box contenitore standard e box contenitore easy-up sono disponibili per giroletto standard e sagomato.
The standard storage box and easy-up storage box are available for both standard and shaped bed frames.

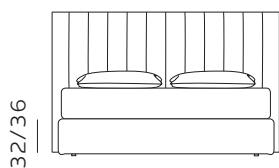

185

materasso largh. cm. 160
mattress width cm. 160

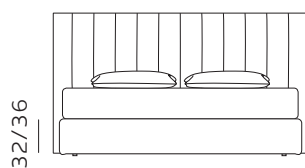

205

materasso largh. cm. 180
mattress width cm. 180

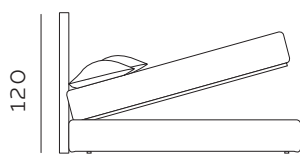

206

materasso lungh. cm. 190
mattress length cm. 190

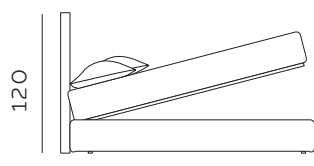

216

materasso lungh. cm. 200
mattress length cm. 200

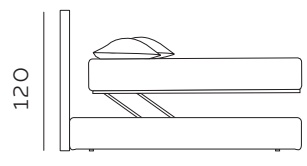

206

materasso lungh. cm. 190
mattress length cm. 190

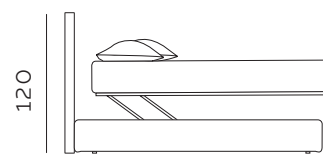

216

materasso lungh. cm. 200
mattress length cm. 200

36

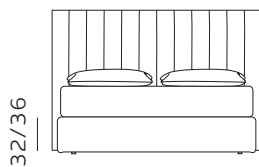

178

materasso largh. cm. 153
mattress width cm. 153

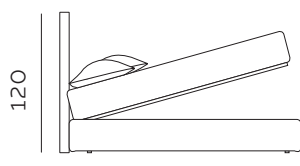

219

materasso lungh. cm. 203
mattress length cm. 203

Per le misure Queen e King non è prevista la versione box contenitore easy-up. / The easy-up box storage version is not available for Queen and King sizes.

RETE DI SERIE per BOX CONTENITORE – Standard o Easy Up - Struttura tubolare in acciaio verniciato a polveri e piano rete doppia campata con 14 listelle in multistrato di faggio misura 68x8 mm. (68x12 mm. nella versione 120) - supporto doghe singolo fisso in nylon anticigolio. Per eventuali richieste di sostituzione della rete di serie con modello alternativo richiedere fattibilità e preventivo all'ufficio vendite. / STANDAR BASE for STORAGE BOX– Standard or Easy Up - Tubular structure in powder-coated steel and a double-span slatted base with 14 beech plywood slats measuring 68x8 mm. (68x12 mm. for the 120 version) - fixed single slat supports in anti-squeak nylon. For any requests to replace the standard base with an alternative model, please request feasibility and quotation from the sales department.

H. 22 GIROLETTO BED FRAME

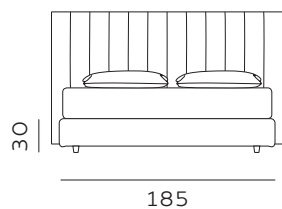

materasso largh. cm. 160
mattress width cm. 160

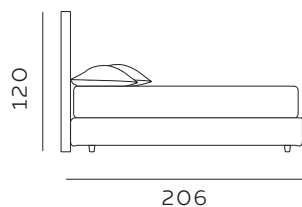

materasso lungh. cm. 190
mattress length cm. 190

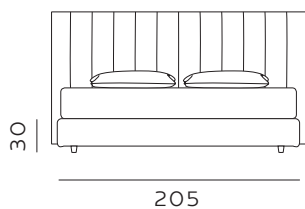

materasso largh. cm. 180
mattress width cm. 180

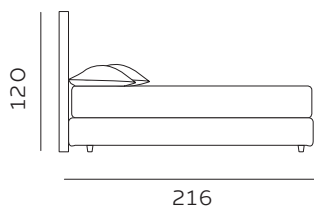

materasso lungh. cm. 200
mattress length cm. 200

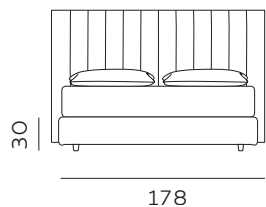

materasso largh. cm. 153
mattress width cm. 153

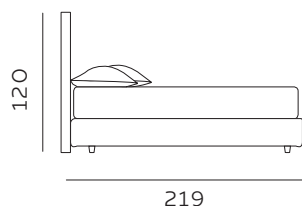

materasso lungh. cm. 203
mattress length cm. 203

H. 22 BOX CONTENITORE STORAGE BOX

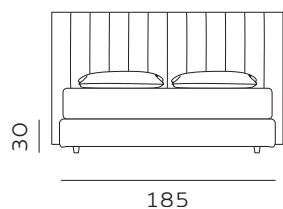

materasso largh. cm. 160
mattress width cm. 160

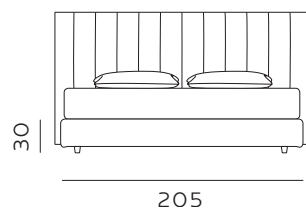

materasso largh. cm. 180
mattress width cm. 180

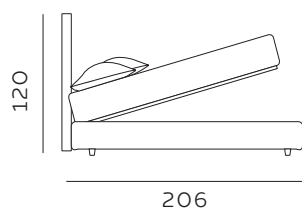

materasso lungh. cm. 190
mattress length cm. 190

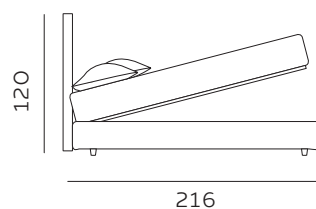

materasso lungh. cm. 200
mattress length cm. 200

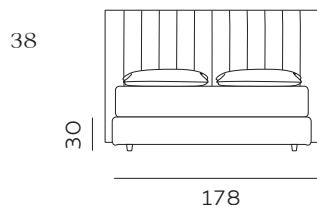

materasso largh. cm. 153
mattress width cm. 153

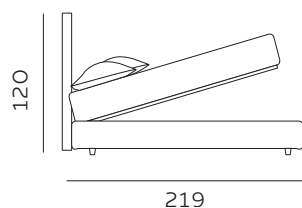

materasso lungh. cm. 203
mattress length cm. 203

RETE DI SERIE per BOX CONTENITORE – Standard o Easy Up – Struttura tubolare in acciaio verniciato a polveri e piano rete doppia campata con 14 listelle in multistrato di faggio misura 68x8 mm. (68x12 mm. nella versione 120) - supporto doghe singolo fisso in nylon anticigolio. Per eventuali richieste di sostituzione della rete di serie con modello alternativo richiedere fattibilità e preventivo all'ufficio vendite. / **STANDAR BASE for STORAGE BOX– Standard or Easy Up –** Tubular structure in powder-coated steel and a double-span slatted base with 14 beech plywood slats measuring 68x8 mm. (68x12 mm. for the 120 version) - fixed single slat supports in anti-squeak nylon. For any requests to replace the standard base with an alternative model, please request feasibility and quotation from the sales department.

PIEDINI PER GIROLETTO h. 22 e 28
FEET FOR BED FRAME h. 22 and 28

Sagomato h. 8 / Shaped h. 8



naturale
natural



wengé
wenge



nero laccato
lacquered black

PIEDINO DI SERIE
PER GIROLETTO h. 22
STANDARD FEET
FOR BED FRAME h. 22

Conico h. 8 / Conical h. 8



nero laccato
lacquered black

PIEDINO DI SERIE
PER GIROLETTO h. 28
STANDARD FEET
FOR BED FRAME h. 28

Cilindro h. 4 / Cylinder h. 4

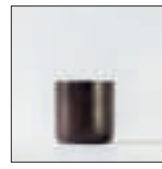

nero laccato
lacquered black

Conico h. 8 / Conical h. 8



naturale
natural



rovere sbiancato
bleached oak



wengé
wenge



noce canaletto
canaletto walnut

Piramide h. 8 / Pyramid h. 8



naturale
natural



rovere sbiancato
bleached oak



wengé
wenge



nero laccato
lacquered black

Trapezio h. 8 / Trapezium h. 8



naturale
natural



nero laccato
lacquered black

Permette il passaggio del robot aspirapolvere
It allows passage for the robot vacuum cleaner



In fase di ordine deve essere specificata la
finitura del piedino laddove richiesto. / Please
specify foot finish when ordering if required.

Istruzioni di montaggio, vedi pag. 120
Assembly instructions, see page 120

Cartella tessuti, vedi pag 130
Fabric samples, see page 130

Listino prezzi, vedi pag 22
Price List, see page 22

OLSEN

Scheda tecnica / Technical data

Olsen è un letto imbottito sfoderabile disponibile in diverse misure. Questo modello può essere realizzato in due diverse altezze di giroletto: la prima di 28 cm., realizzabile anche con giroletto sagomato, con box standard o easy-up, la seconda di 22 cm., anche con box contenitore. Viene personalizzato con piedini dalle diverse tipologie e finiture: piedini di altezza 8 cm. e di serie di 4 cm. per il giroletto da 28 cm., piedini di altezza 8 cm. per il giroletto da 22 cm.

Olsen is an upholstered, removable bed available in different sizes. It can be crafted with two different bed frame heights: 28 cm., also in a shaped version, available with standard storage box and easy-up box system, and 22 cm., available with storage box. This model can be customized with feet of different types, height and finishes: 8 cm. feet and standard 4 cm. feet for the 28 cm. bed frame, 8 cm. feet for the 22 cm. bed frame.

Immagine in alto
testiera / giroletto: Quebec O2
piedini: conico naturale h. 8 cm.
Immagine in basso
testiera / giroletto: Elegant Wish O2
piedini: cilindro nero laccato h. 4 cm.

40

Image above
headboard / bed frame: Quebec O2
feet: natural conical h. 8 cm.
Image below
headboard / bed frame: Elegant Wish O2
feet: black lacquered cylinder h. 4 cm.



igiene sicura sfoderabile
e lavabile / safe hygiene
removable and washable



DIMENSIONI DISPONIBILI / AVAILABLE SIZES

matrimoniale 160x190 / 160x200 cm.
matrimoniale xl 180x190 / 180x200 cm.
queen 153x203 cm.
king 193x203 cm.
matrimoniale xxl 200x200 cm.

*double bed 160x190 / 160x200 cm.
double bed xl 180x190 / 180x200 cm.
queen 153x203 cm.
king 193x203 cm.
double bed xxl 200x200 cm.*

H. 28 GIROLETTO / GIROLETTO SAGOMATO

BED FRAME / SHAPED BED FRAME

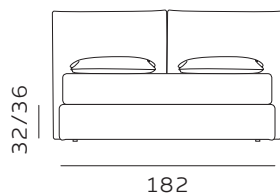

materasso largh. cm. 160
mattress width cm. 160

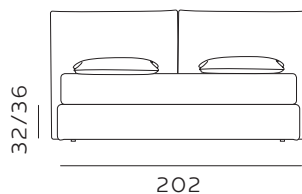

materasso largh. cm. 180
mattress width cm. 180

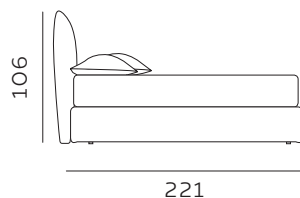

materasso lungh. cm. 190
mattress length cm. 190

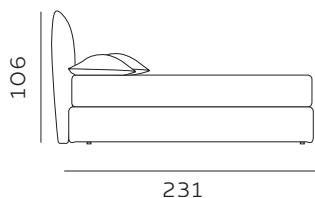

materasso lungh. cm. 200
mattress length cm. 200

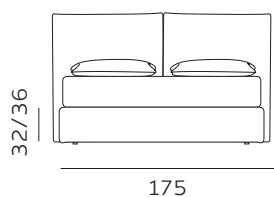

materasso largh. cm. 153
mattress width cm. 153

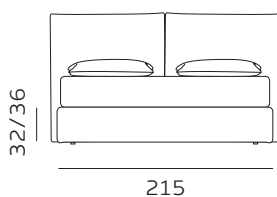

materasso largh. cm. 193
mattress width cm. 193

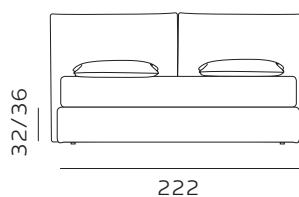

materasso largh. cm. 200
mattress width cm. 200

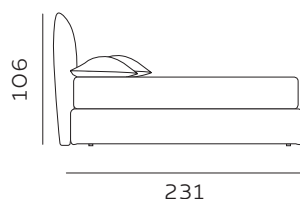

materasso lungh. cm. 200
mattress length cm. 200

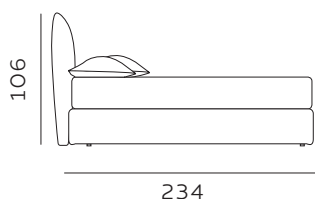

materasso lungh. cm. 203
mattress length cm. 203

H. 28 BOX CONTENITORE / BOX CONTENITORE EASY-UP STORAGE BOX / STORAGE BOX EASY-UP

Il box contenitore standard e box contenitore easy-up sono disponibili per giroletto standard e sagomato.
The standard storage box and easy-up storage box are available for both standard and shaped bed frames.

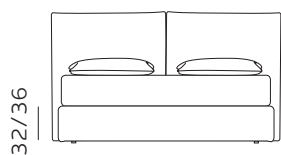

182

materasso largh. cm. 160
mattress width cm. 160

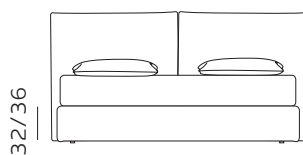

202

materasso largh. cm. 180
mattress width cm. 180

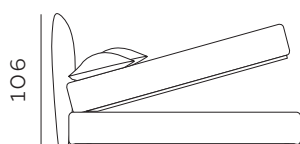

221

materasso lungh. cm. 190
mattress length cm. 190

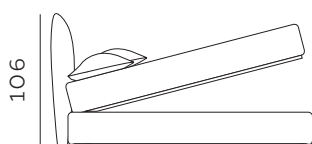

231

materasso lungh. cm. 200
mattress length cm. 200

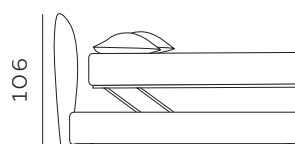

221

materasso lungh. cm. 190
mattress length cm. 190

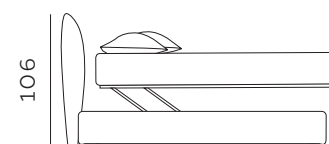

231

materasso lungh. cm. 200
mattress length cm. 200

42

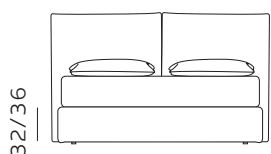

175

materasso largh. cm. 153
mattress width cm. 153

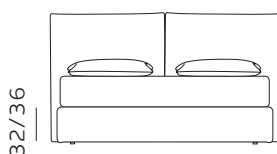

215

materasso largh. cm. 193
mattress width cm. 193

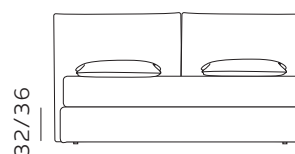

222

materasso largh. cm. 200
mattress width cm. 200

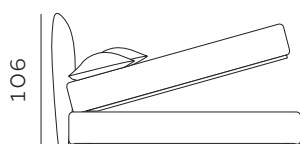

231

materasso lungh. cm. 200
mattress length cm. 200

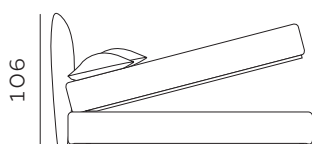

234

materasso lungh. cm. 203
mattress length cm. 203

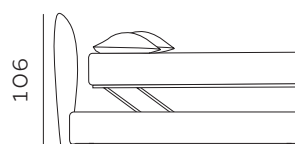

231

materasso lungh. cm. 200
mattress length cm. 200

Per le misure Queen e King non è prevista la versione box contenitore easy-up. / The easy-up box storage version is not available for Queen and King sizes.

RETE DI SERIE per BOX CONTENITORE – Standard o Easy Up - Struttura tubolare in acciaio verniciato a polveri e piano rete doppia campata con 14 listelle in multistrato di faggio misura 68x8 mm. (68x12 mm. nella versione 120) - supporto doghe singolo fisso in nylon anticigolio. Per eventuali richieste di sostituzione della rete di serie con modello alternativo richiedere fattibilità e preventivo all'ufficio vendite. / STANDAR BASE for STORAGE BOX– Standard or Easy Up - Tubular structure in powder-coated steel and a double-span slatted base with 14 beech plywood slats measuring 68x8 mm. (68x12 mm. for the 120 version) - fixed single slat supports in anti-squeak nylon. For any requests to replace the standard base with an alternative model, please request feasibility and quotation from the sales department.

H. 22 GIROLETTO BED FRAME

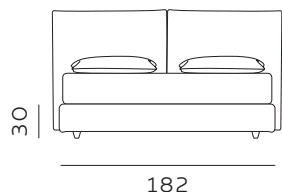

182
materasso largh. cm. 160
mattress width cm. 160

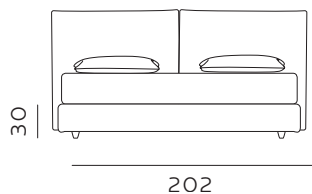

202
materasso largh. cm. 180
mattress width cm. 180

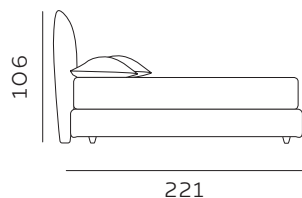

221
materasso lungh. cm. 190
mattress length cm. 190

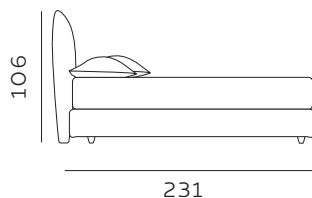

231
materasso lungh. cm. 200
mattress length cm. 200

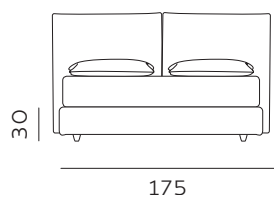

175
materasso largh. cm. 153
mattress width cm. 153

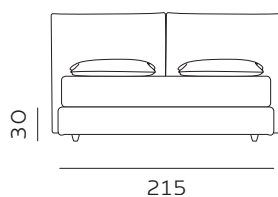

215
materasso largh. cm. 193
mattress width cm. 193

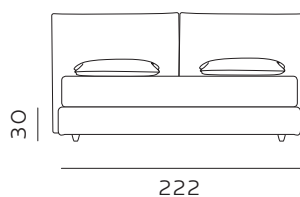

222
materasso largh. cm. 200
mattress width cm. 200

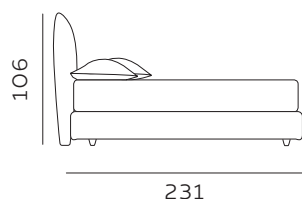

231
materasso lungh. cm. 200
mattress length cm. 200

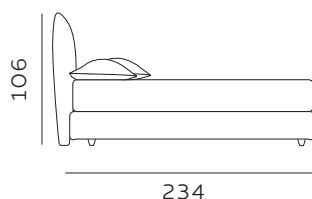

234
materasso lungh. cm. 203
mattress length cm. 203

H. 22 BOX CONTENITORE STORAGE BOX

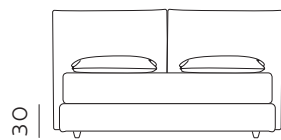

182

materasso largh. cm. 160
mattress width cm. 160

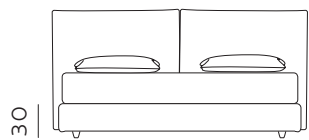

202

materasso largh. cm. 180
mattress width cm. 180

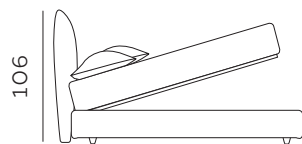

221

materasso lungh. cm. 190
mattress length cm. 190

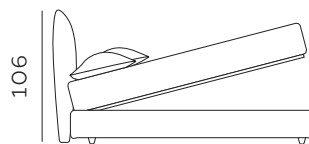

231

materasso lungh. cm. 200
mattress length cm. 200

44

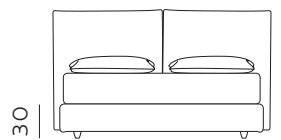

175

materasso largh. cm. 153
mattress width cm. 153

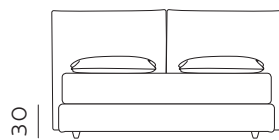

215

materasso largh. cm. 193
mattress width cm. 193

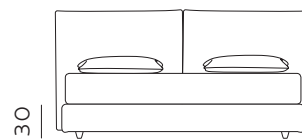

222

materasso largh. cm. 200
mattress width cm. 200

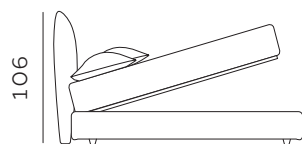

231

materasso lungh. cm. 200
mattress length cm. 200

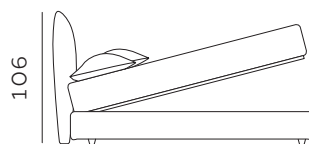

234

materasso lungh. cm. 203
mattress length cm. 203

RETE DI SERIE per BOX CONTENITORE – Standard o Easy Up – Struttura tubolare in acciaio verniciato a polveri e piano rete doppia campata con 14 listelle in multistrato di faggio misura 68x8 mm. (68x12 mm. nella versione 120) - supporto doghe singolo fisso in nylon anticigolio. Per eventuali richieste di sostituzione della rete di serie con modello alternativo richiedere fattibilità e preventivo all'ufficio vendite. / STANDAR BASE for STORAGE BOX– Standard or Easy Up - Tubular structure in powder-coated steel and a double-span slatted base with 14 beech plywood slats measuring 68x8 mm. (68x12 mm. for the 120 version) - fixed single slat supports in anti-squeak nylon. For any requests to replace the standard base with an alternative model, please request feasibility and quotation from the sales department.

PIEDINI PER GIROLETTO h. 22 e 28
FEET FOR BED FRAME h. 22 and 28

Sagomato h. 8 / Shaped h. 8



naturale
natural



wengé
wenge



nero laccato
lacquered black

**PIEDINO DI SERIE
PER GIROLETTO h. 22**
*STANDARD FEET
FOR BED FRAME h. 22*

Conico h. 8 / Conical h. 8



nero laccato
lacquered black

**PIEDINO DI SERIE
PER GIROLETTO h. 28**
*STANDARD FEET
FOR BED FRAME h. 28*

Cilindro h. 4 / Cylinder h. 4



nero laccato
lacquered black

Conico h. 8 / Conical h. 8



naturale
natural



rovere sbiancato
bleached oak



wengé
wenge



noce canaletto
canaletto walnut

Piramide h. 8 / Pyramid h. 8



naturale
natural



rovere sbiancato
bleached oak



wengé
wenge



nero laccato
lacquered black

Trapezio h. 8 / Trapezium h. 8



naturale
natural



nero laccato
lacquered black

Permette il passaggio del robot aspirapolvere
It allows passage for the robot vacuum cleaner



In fase di ordine deve essere specificata la
finitura del piedino laddove richiesto. / *Please*
specify foot finish when ordering if required.

Istruzioni di montaggio, vedi pag. 120
Assembly instructions, see page 120

Cartella tessuti, vedi pag 130
Fabric samples, see page 130

Listino prezzi, vedi pag 24
Price List, see page 24

VIVIENNE

Scheda tecnica / Technical data

Il letto Vivienne è un letto imbottito sfoderabile disponibile in tutte le misure e realizzabile nelle tre altezze di giroletto: 28 cm. con box standard o versione easy-up con piedini di altezza 8 cm. e di serie di 4 cm., 22 cm. anche box contenitore e piedini di altezza 8 cm., 15 cm. con piedino conico o angolare di altezza 13 cm.

The Vivienne bed is an upholstered, removable model available in all sizes and in three different bed frame heights: 28 cm. available with standard box or easy-up box system with 8 cm. feet or standard feet of 4 cm.; 22 cm. with storage box and 8 cm. feet, and 15 cm. with cone or angular 13 cm. feet.



Immagine in alto
testiera / giroletto: Pinò 302
piedini: trapezio nero laccato h. 8 cm.
Immagine in basso
testiera / giroletto: Pop 111
piedini: conico nero laccato h. 13 cm.

46

Image above
headboard / bed frame: Pinò 302
feet: black lacquered trapezium h. 8 cm.
Image below
headboard / bed frame: Pop 111
feet: black lacquered conical h. 13 cm.



igiene sicura sfoderabile
e lavabile / safe hygiene
removable and washable



I bottoni sono realizzati in tessuto personalizzabile, selezionabile dal campionario.

The buttons are made of customizable fabric, selectable from the fabric sample.

DIMENSIONI DISPONIBILI / AVAILABLE SIZES

singolo 80x190 / 80x200 cm.
piazza e mezza 120x190 / 120x200 cm.
matrimoniale 160x190 / 160x200 cm.
matrimoniale xl 180x190 / 180x200 cm.
queen 153x203 cm.
king 193x203 cm.
matrimoniale xxl 200x200 cm.

*single 80x190 / 80x200 cm.
three-quarter size 120x190 / 120x200 cm.
double bed size 160x190 / 160x200 cm.
double bed xl 180x190 / 180x200 cm.
queen 153x203 cm.
king 193x203 cm.
double bed xxl 200x200 cm.*

H. 28 GIROLETTO BED FRAME

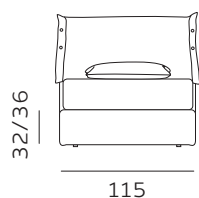

32/36
115
materasso largh. cm. 80
mattress width cm. 80

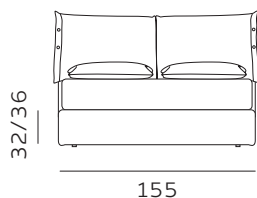

32/36
155
materasso largh. cm. 120
mattress width cm. 120

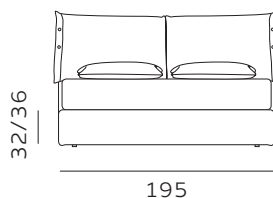

32/36
195
materasso largh. cm. 160
mattress width cm. 160

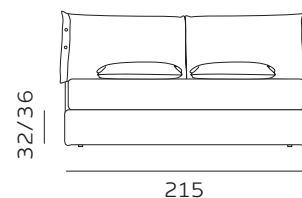

32/36
215
materasso largh. cm. 180
mattress width cm. 180

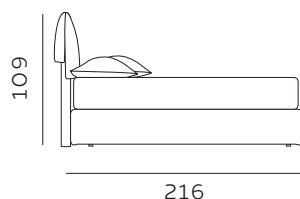

109
216
materasso lungh. cm. 190
mattress length cm. 190

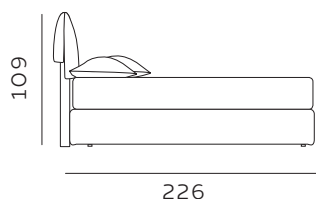

109
226
materasso lungh. cm. 200
mattress length cm. 200

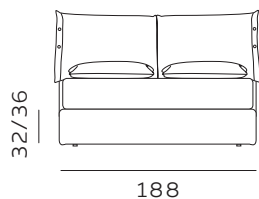

32/36
188
materasso largh. cm. 153
mattress width cm. 153

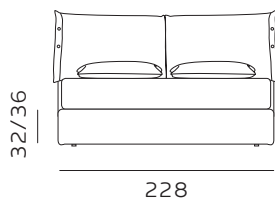

32/36
228
materasso largh. cm. 193
mattress width cm. 193

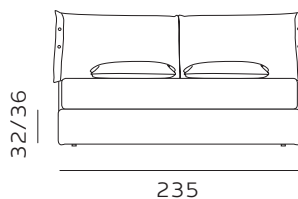

32/36
235
materasso largh. cm. 200
mattress width cm. 200

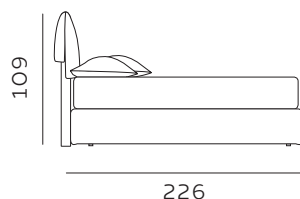

109
226
materasso lungh. cm. 200
mattress length cm. 200

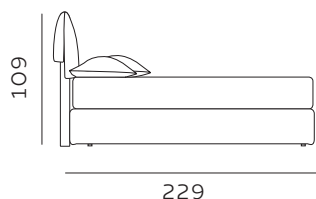

109
229
materasso lungh. cm. 203
mattress length cm. 203

H. 28 BOX CONTENITORE / BOX CONTENITORE EASY-UP STORAGE BOX / STORAGE BOX EASY-UP

Il box contenitore standard e box contenitore easy-up sono disponibili per giroletto standard e sagomato.
The standard storage box and easy-up storage box are available for both standard and shaped bed frames.

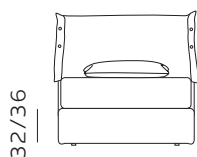

115

materasso largh. cm. 80
mattress width cm. 80

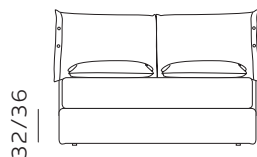

155

materasso largh. cm. 120
mattress width cm. 120

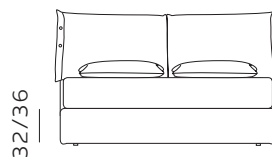

195

materasso largh. cm. 160
mattress width cm. 160

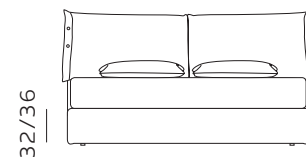

215

materasso largh. cm. 180
mattress width cm. 180

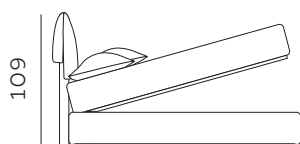

216

materasso lungh. cm. 190
mattress length cm. 190

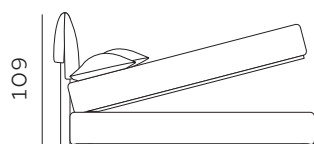

226

materasso lungh. cm. 200
mattress length cm. 200

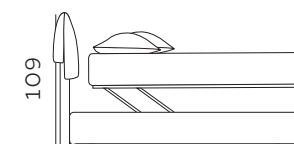

216

materasso lungh. cm. 190
mattress length cm. 190

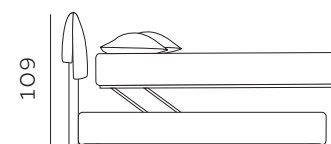

226

materasso lungh. cm. 200
mattress length cm. 200

48

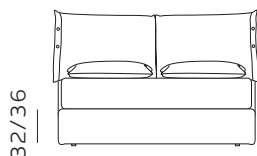

188

materasso largh. cm. 153
mattress width cm. 153

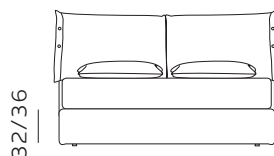

228

materasso largh. cm. 193
mattress width cm. 193

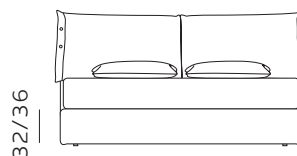

235

materasso largh. cm. 200
mattress width cm. 200

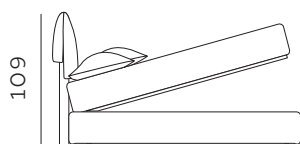

226

materasso lungh. cm. 200
mattress length cm. 200

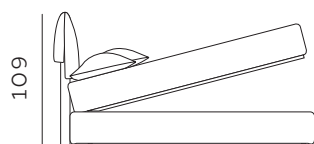

229

materasso lungh. cm. 203
mattress length cm. 203

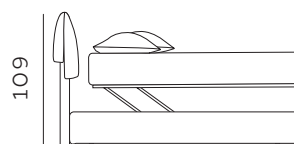

226

materasso lungh. cm. 200
mattress length cm. 200

Per le misure Queen e King non è prevista la versione box contenitore easy-up. / The easy-up box storage version is not available for Queen and King sizes.

RETE DI SERIE per BOX CONTENITORE – Standard o Easy Up - Struttura tubolare in acciaio verniciato a polveri e piano rete doppia campata con 14 listelle in multistrato di faggio misura 68x8 mm. (68x12 mm. nella versione 120) - supporto doghe singolo fisso in nylon anticigolio. Per eventuali richieste di sostituzione della rete di serie con modello alternativo richiedere fattibilità e preventivo all'ufficio vendite. / STANDAR BASE for STORAGE BOX– Standard or Easy Up - Tubular structure in powder-coated steel and a double-span slatted base with 14 beech plywood slats measuring 68x8 mm. (68x12 mm. for the 120 version) - fixed single slat supports in anti-squeak nylon. For any requests to replace the standard base with an alternative model, please request feasibility and quotation from the sales department.

H. 22 GIROLETTO BED FRAME

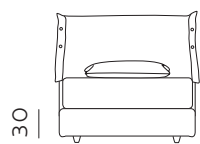

115

materasso largh. cm. 80
mattress width cm. 80

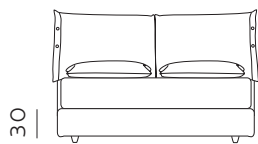

155

materasso largh. cm. 120
mattress width cm. 120

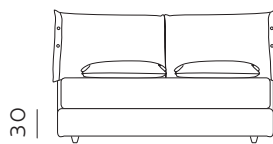

195

materasso largh. cm. 160
mattress width cm. 160

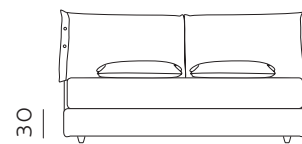

215

materasso largh. cm. 180
mattress width cm. 180

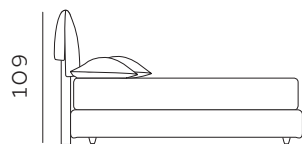

216

materasso lungh. cm. 190
mattress length cm. 190

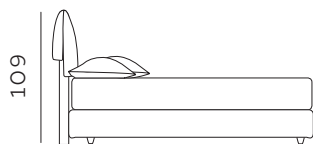

226

materasso lungh. cm. 200
mattress length cm. 200

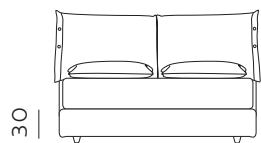

188

materasso largh. cm. 153
mattress width cm. 153

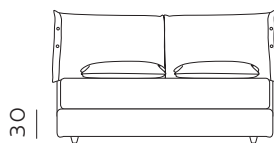

228

materasso largh. cm. 193
mattress width cm. 193

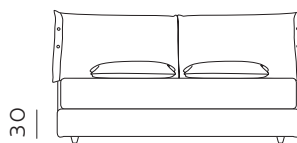

235

materasso largh. cm. 200
mattress width cm. 200

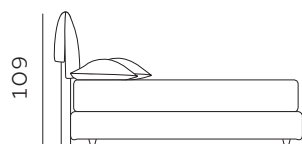

226

materasso lungh. cm. 200
mattress length cm. 200

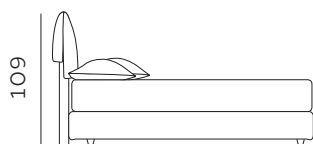

229

materasso lungh. cm. 203
mattress length cm. 203

H. 22 BOX CONTENITORE STORAGE BOX

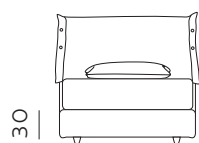

115

materasso largh. cm. 80
mattress width cm. 80

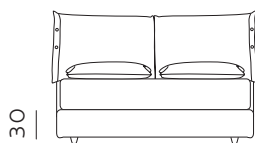

155

materasso largh. cm. 120
mattress width cm. 120

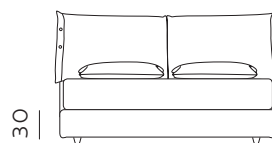

195

materasso largh. cm. 160
mattress width cm. 160

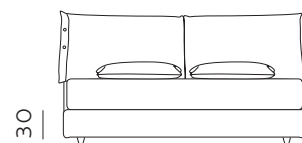

215

materasso largh. cm. 180
mattress width cm. 180

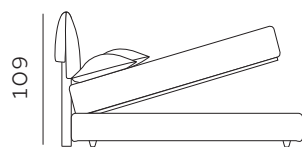

216

materasso lungh. cm. 190
mattress length cm. 190

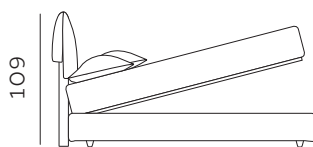

226

materasso lungh. cm. 200
mattress length cm. 200

50

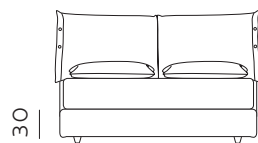

188

materasso largh. cm. 153
mattress width cm. 153

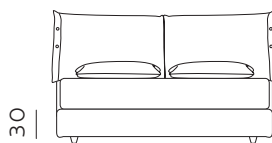

228

materasso largh. cm. 193
mattress width cm. 193

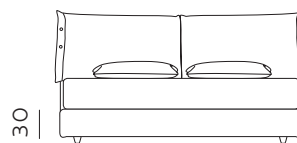

235

materasso largh. cm. 200
mattress width cm. 200

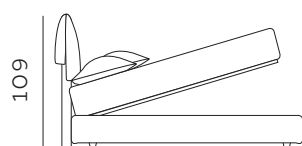

226

materasso lungh. cm. 200
mattress length cm. 200

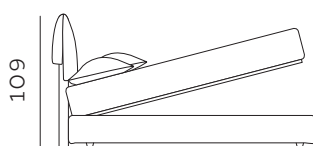

229

materasso lungh. cm. 203
mattress length cm. 203

RETE DI SERIE per BOX CONTENITORE – Standard o Easy Up – Struttura tubolare in acciaio verniciato a polveri e piano rete doppia campata con 14 listelle in multistrato di faggio misura 68x8 mm. (68x12 mm. nella versione 120) - supporto doghe singolo fisso in nylon anticigolio. Per eventuali richieste di sostituzione della rete di serie con modello alternativo richiedere fattibilità e preventivo all'ufficio vendite. / STANDAR BASE for STORAGE BOX– Standard or Easy Up - Tubular structure in powder-coated steel and a double-span slatted base with 14 beech plywood slats measuring 68x8 mm. (68x12 mm. for the 120 version) - fixed single slat supports in anti-squeak nylon. For any requests to replace the standard base with an alternative model, please request feasibility and quotation from the sales department.

PIEDINI PER GIROLETTO h. 22 e 28
FEET FOR BED FRAME h. 22 and 28

Sagomato h. 8 / Shaped h. 8



naturale
natural



wengé
wenge



nero laccato
lacquered black

**PIEDINO DI SERIE
PER GIROLETTO h. 22**
*STANDARD FEET
FOR BED FRAME h. 22*

Conico h. 8 / Conical h. 8



nero laccato
lacquered black

**PIEDINO DI SERIE
PER GIROLETTO h. 28**
*STANDARD FEET
FOR BED FRAME h. 28*

Cilindro h. 4 / Cylinder h. 4

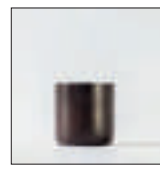

nero laccato
lacquered black

Conico h. 8 / Conical h. 8



naturale
natural



rovere sbiancato
bleached oak



wengé
wenge



noce canaletto
canaletto walnut

Piramide h. 8 / Pyramid h. 8



naturale
natural



rovere sbiancato
bleached oak



wengé
wenge



nero laccato
lacquered black

Trapezio h. 8 / Trapezium h. 8



naturale
natural



nero laccato
lacquered black

Permette il passaggio del robot aspirapolvere
It allows passage for the robot vacuum cleaner



In fase di ordine deve essere specificata la
finitura del piedino laddove richiesto. / *Please*
specify foot finish when ordering if required.

Istruzioni di montaggio, vedi pag. 120
Assembly instructions, see page 120

Cartella tessuti, vedi pag 130
Fabric samples, see page 130

Listino prezzi, vedi pag 28
Price List, see page 28

H. 15

GIROLETTO
BED FRAME

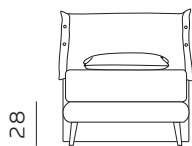

115

materasso largh. cm. 80
mattress width cm. 80

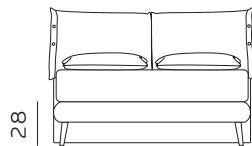

155

materasso largh. cm. 120
mattress width cm. 120

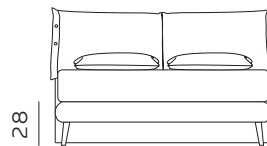

195

materasso largh. cm. 160
mattress width cm. 160

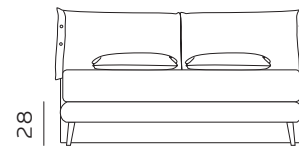

215

materasso largh. cm. 180
mattress width cm. 180

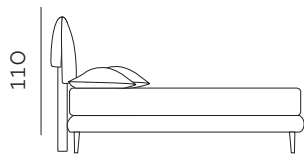

216

materasso lungh. cm. 190
mattress length cm. 190

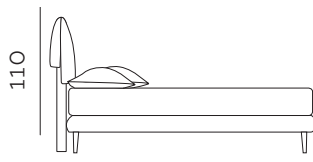

226

materasso lungh. cm. 200
mattress length cm. 200

52

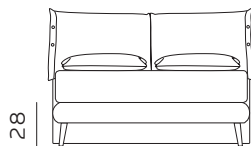

188

materasso largh. cm. 153
mattress width cm. 153

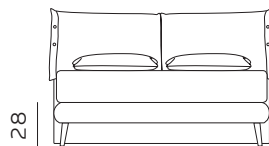

228

materasso largh. cm. 193
mattress width cm. 193

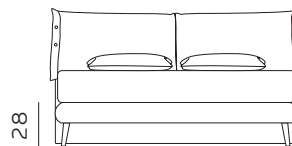

235

materasso largh. cm. 200
mattress width cm. 200

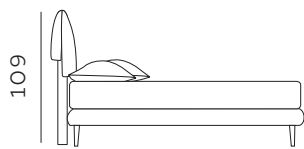

226

materasso lungh. cm. 200
mattress length cm. 200

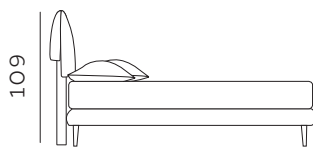

229

materasso lungh. cm. 203
mattress length cm. 203

PIEDINI / FEET

Conico h. 13 / Conical h. 13



naturale
natural



rovere sbiancato
bleached oak



wengé
wenge



noce canaletto
canaletto walnut

PIEDINO DI SERIE
PER GIROLETTO h. 15
STANDARD FEET
FOR BED FRAME h. 15
Conico h. 13 / Conical h. 13

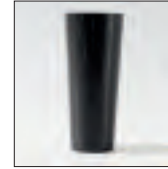

nero laccato
lacquered black

Metallo angolare h. 13 / Angular metal h. 13



metallo nero
black metal

Permette il passaggio del robot aspirapolvere
It allows passage for the robot vacuum cleaner



In fase di ordine deve essere specificata la
finitura del piedino laddove richiesto. / Please
specify foot finish when ordering if required.

Istruzioni di montaggio, vedi pag. 122
Assembly instructions, see page 122

Cartella tessuti, vedi pag 130
Fabric samples, see page 130

Listino prezzi, vedi pag 28
Price List, see page 28

NEST

Scheda tecnica / Technical data

Il letto imbottito Nest è sfoderabile e disponibile in diverse misure. Presenta un'unica altezza di giroletto, realizzabile in versione classica o sagomata, entrambe personalizzabili con box contenitore standard o easy-up. È completato da piedini di serie da 4 cm.

The Nest is a removable upholstered bed, available in various sizes. It features a single bed frame height, which can be made with classic or shaped design, both available with standard or easy-up storage box. It is completed with the standard 4 cm. feet option.



Immagine in alto
testiera / giroletto: Salice 18
piedini: cilindro nero laccato h. 4 cm.
Immagine in basso
testiera / giroletto: Oviedo 46
piedini: cilindro nero laccato h. 4 cm.

54

Image above
headboard / bed frame: Salice 18
feet: black lacquered cylinder h. 4 cm.
Image below
headboard / bed frame: Oviedo 46
feet: black lacquered cylinder h. 4 cm.



igiene sicura sfoderabile
e lavabile / safe hygiene
removable and washable



DIMENSIONI DISPONIBILI / AVAILABLE SIZES

matrimoniale 160x190 / 160x200 cm.
matrimoniale xl 180x190 / 180x200 cm.
queen 153x203 cm.
king 193x203 cm.
matrimoniale xxl 200x200 cm.

*double bed 160x190 / 160x200 cm.
double bed xl 180x190 / 180x200 cm.
queen 153x203 cm.
king 193x203 cm.
double bed xxl 200x200 cm.*

H. 28 GIROLETTO / GIROLETTO SAGOMATO

BED FRAME / SHAPED BED FRAME

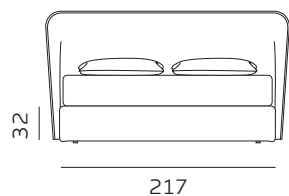

materasso largh. cm. 160
mattress width cm. 160

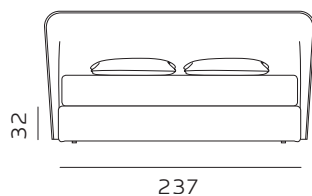

materasso largh. cm. 180
mattress width cm. 180

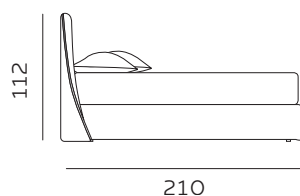

materasso lungh. cm. 190
mattress length cm. 190

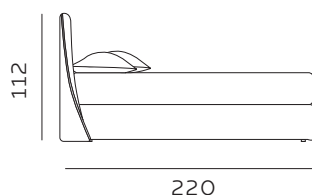

materasso lungh. cm. 200
mattress length cm. 200

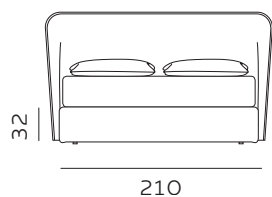

materasso largh. cm. 153
mattress width cm. 153

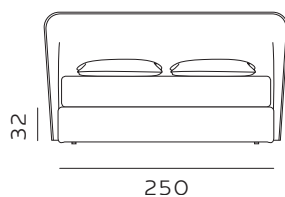

materasso largh. cm. 193
mattress width cm. 193

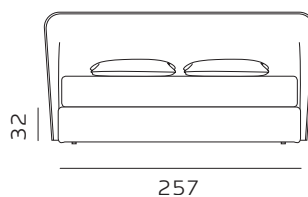

materasso largh. cm. 200
mattress width cm. 200

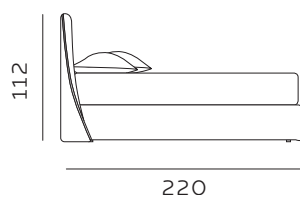

materasso lungh. cm. 200
mattress length cm. 200

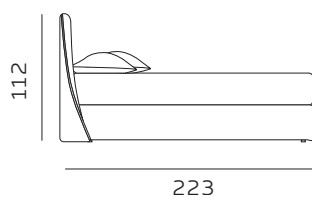

materasso lungh. cm. 203
mattress length cm. 203

H. 28 BOX CONTENITORE / BOX CONTENITORE EASY-UP STORAGE BOX / STORAGE BOX EASY-UP

Il box contenitore standard e box contenitore easy-up sono disponibili per giroletto standard e sagomato.
The standard storage box and easy-up storage box are available for both standard and shaped bed frames.

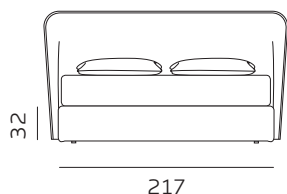

materasso largh. cm. 160
mattress width cm. 160

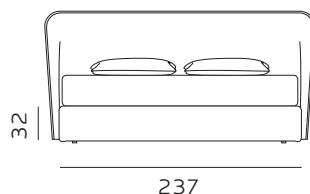

materasso largh. cm. 180
mattress width cm. 180

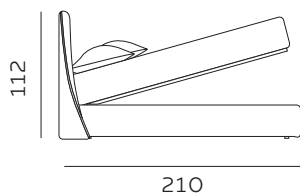

materasso lungh. cm. 190
mattress length cm. 190

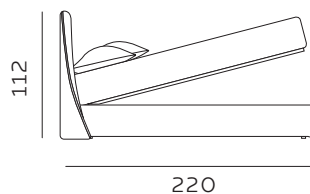

materasso lungh. cm. 200
mattress length cm. 200

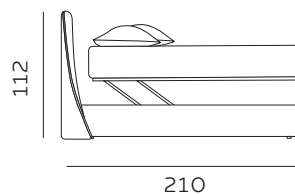

materasso lungh. cm. 190
mattress length cm. 190

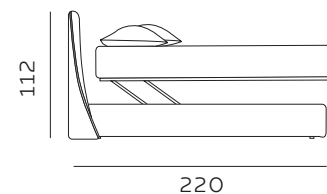

materasso lungh. cm. 200
mattress length cm. 200

56

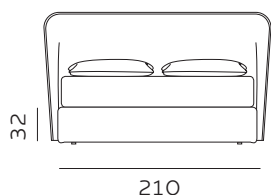

materasso largh. cm. 153
mattress width cm. 153

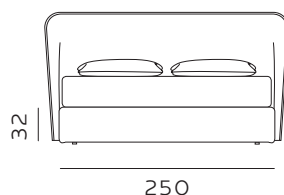

materasso largh. cm. 193
mattress width cm. 193

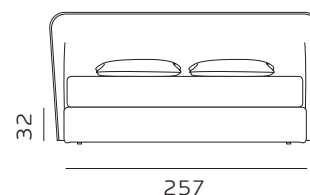

materasso largh. cm. 200
mattress width cm. 200

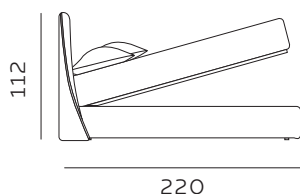

materasso lungh. cm. 200
mattress length cm. 200

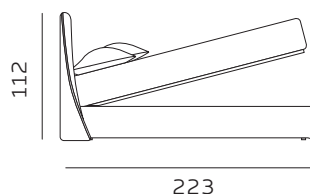

materasso lungh. cm. 203
mattress length cm. 203

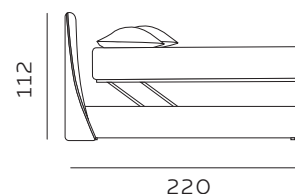

materasso lungh. cm. 200
mattress length cm. 200

Per le misure Queen e King non è prevista la versione box contenitore easy-up. / The easy-up box storage version is not available for Queen and King sizes.

RETE DI SERIE per BOX CONTENITORE – Standard o Easy Up - Struttura tubolare in acciaio verniciato a polveri e piano rete doppia campata con 14 listelle in multistrato di faggio misura 68x8 mm. (68x12 mm. nella versione 120) - supporto doghe singolo fisso in nylon anticigolio. Per eventuali richieste di sostituzione della rete di serie con modello alternativo richiedere fattibilità e preventivo all'ufficio vendite. / STANDAR BASE for STORAGE BOX– Standard or Easy Up - Tubular structure in powder-coated steel and a double-span slatted base with 14 beech plywood slats measuring 68x8 mm. (68x12 mm. for the 120 version) - fixed single slat supports in anti-squeak nylon. For any requests to replace the standard base with an alternative model, please request feasibility and quotation from the sales department.

PIEDINO DI SERIE
PER GIROLETTO h. 28
STANDARD FEET
FOR BED FRAME h. 28
Cilindro h. 4 / *Cylinder h. 4*

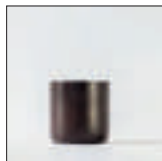

nero laccato
lacquered black

Istruzioni di montaggio, vedi pag. 120
Assembly instructions, see page 120

Cartella tessuti, vedi pag 130
Fabric samples, see page 130

Listino prezzi, vedi pag 32
Price List, see page 32

ARCADIA

Scheda tecnica / Technical data

Il letto Arcadia è un letto imbottito sfoderabile disponibile in tutte le misure. Questo modello è realizzabile nelle tre altezze di giroletto: 28 cm. con box standard o versione easy-up con piedini di altezza 8 cm. e di serie di 4 cm., 22 cm. anche box contenitore e piedini di altezza 8 cm., 15 cm. con piedino conico o angolare di altezza 13 cm.

Arcadia is an upholstered, removable bed available in all sizes. This model can be made in three different bed frame heights: 28 cm. available with standard box or easy-up box system with 8 cm. feet or standard feet of 4 cm.; 22 cm., with storage box and 8 cm. feet, and 15 cm. with cone or angular 13 cm. feet.



Immagine in alto
testiera / giroletto: Cali 727
dettaglio testiera: Cali 716
piedini: cilindro nero laccato h. 4 cm.
Immagine in basso
testiera / giroletto: Salice 20
dettaglio testiera: Nobilbond 01
piedini: conico nero laccato h. 13 cm.

58

Image above
headboard / bed frame: Cali 727
headboard detail: Cali 716
feet: black lacquered cylinder h. 4 cm.
Image below
headboard / bed frame: Salice 20
headboard detail: Nobilbond 01
feet: black lacquered conical h. 13 cm.



igiene sicura sfoderabile
e lavabile / safe hygiene
removable and washable



Dopo aver scelto il rivestimento della testiera, specificare se il dettaglio laterale presente nella curvatura deve essere in tinta o a contrasto. Se a contrasto, selezionare un colore dalle mazzette tessuti presenti nel campionario collezione letti.

After choosing the headboard covering, specify whether the side detail present in the curve should match or contrast. If contrasting, select a color from the fabric swatches available in the bed collection sample book.

DIMENSIONI DISPONIBILI / AVAILABLE SIZES

singolo 80x190 / 80x200 cm.
piazza e mezza 120x190 / 120x200 cm.
matrimoniale 160x190 / 160x200 cm.
matrimoniale xl 180x190 / 180x200 cm.
queen 153x203 cm.
king 193x203 cm.
matrimoniale xxl 200x200 cm.

*single 80x190 / 80x200 cm.
three-quarter size 120x190 / 120x200 cm.
double bed size 160x190 / 160x200 cm.
double bed xl 180x190 / 180x200 cm.
queen 153x203 cm.
king 193x203 cm.
double bed xxl 200x200 cm.*

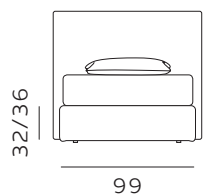

materasso largh. cm. 80
mattress width cm. 80

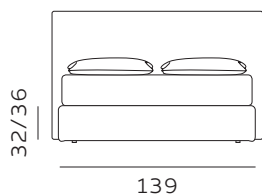

materasso largh. cm. 120
mattress width cm. 120

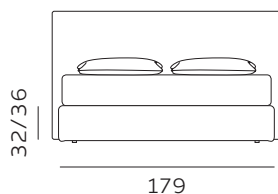

materasso largh. cm. 160
mattress width cm. 160

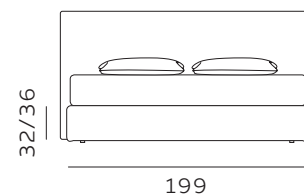

materasso largh. cm. 180
mattress width cm. 180

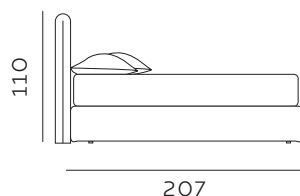

materasso lungh. cm. 190
mattress length cm. 190

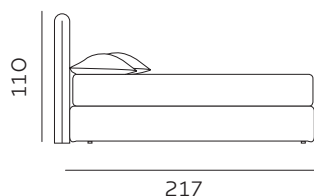

materasso lungh. cm. 200
mattress length cm. 200

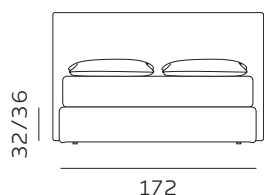

materasso largh. cm. 153
mattress width cm. 153

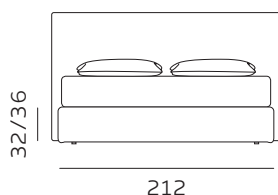

materasso largh. cm. 193
mattress width cm. 193

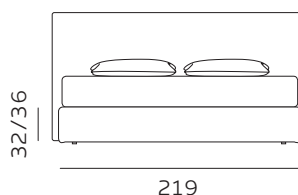

materasso largh. cm. 200
mattress width cm. 200

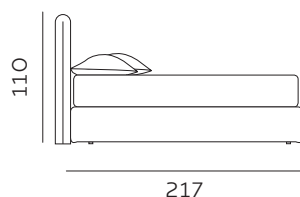

materasso lungh. cm. 200
mattress length cm. 200

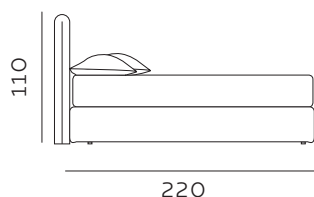

materasso lungh. cm. 203
mattress length cm. 203

H. 28 BOX CONTENITORE / BOX CONTENITORE EASY-UP STORAGE BOX / STORAGE BOX EASY-UP

Il box contenitore standard e box contenitore easy-up sono disponibili per giroletto standard e sagomato.
The standard storage box and easy-up storage box are available for both standard and shaped bed frames.

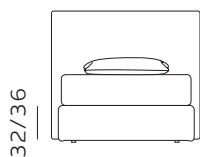

99

materasso largh. cm. 80
mattress width cm. 80

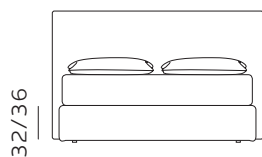

139

materasso largh. cm. 120
mattress width cm. 120

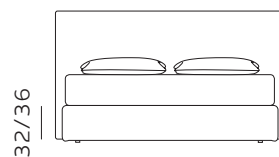

179

materasso largh. cm. 160
mattress width cm. 160

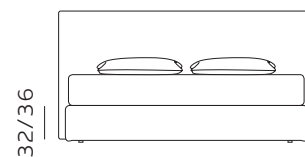

199

materasso largh. cm. 180
mattress width cm. 180

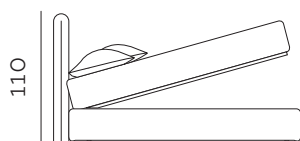

207

materasso lungh. cm. 190
mattress length cm. 190

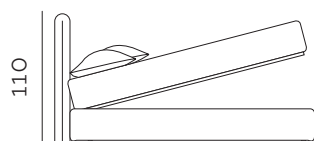

217

materasso lungh. cm. 200
mattress length cm. 200

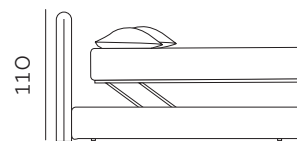

207

materasso lungh. cm. 190
mattress length cm. 190

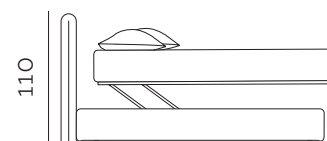

217

materasso lungh. cm. 200
mattress length cm. 200

60

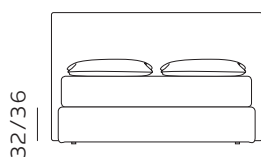

172

materasso largh. cm. 153
mattress width cm. 153

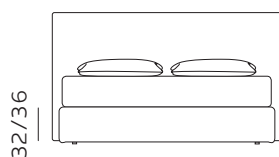

212

materasso largh. cm. 193
mattress width cm. 193

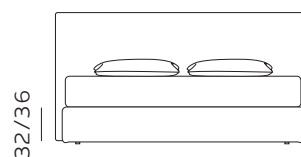

219

materasso largh. cm. 200
mattress width cm. 200

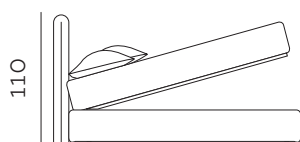

217

materasso lungh. cm. 200
mattress length cm. 200

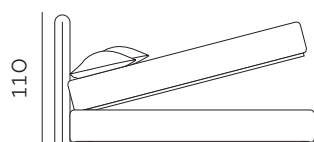

220

materasso lungh. cm. 203
mattress length cm. 203

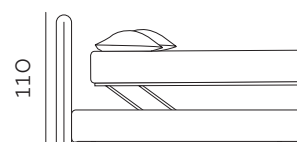

217

materasso lungh. cm. 200
mattress length cm. 200

Per le misure Queen e King non è prevista la versione box contenitore easy-up. / The easy-up box storage version is not available for Queen and King sizes.

RETE DI SERIE per BOX CONTENITORE – Standard o Easy Up - Struttura tubolare in acciaio verniciato a polveri e piano rete doppia campata con 14 listelle in multistrato di faggio misura 68x8 mm. (68x12 mm. nella versione 120) - supporto doghe singolo fisso in nylon anticigolio. Per eventuali richieste di sostituzione della rete di serie con modello alternativo richiedere fattibilità e preventivo all'ufficio vendite. / STANDAR BASE for STORAGE BOX– Standard or Easy Up - Tubular structure in powder-coated steel and a double-span slatted base with 14 beech plywood slats measuring 68x8 mm. (68x12 mm. for the 120 version) - fixed single slat supports in anti-squeak nylon. For any requests to replace the standard base with an alternative model, please request feasibility and quotation from the sales department.

H. 22 GIROLETTO BED FRAME

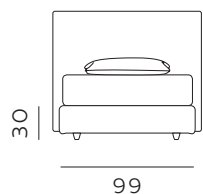

99
materasso largh. cm. 80
mattress width cm. 80

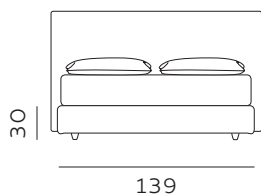

139
materasso largh. cm. 120
mattress width cm. 120

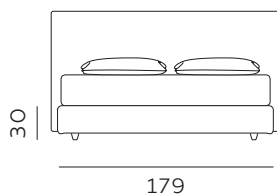

179
materasso largh. cm. 160
mattress width cm. 160

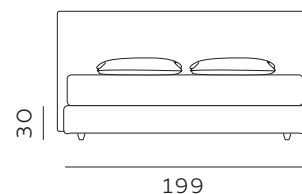

199
materasso largh. cm. 180
mattress width cm. 180

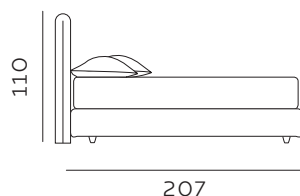

207
materasso lungh. cm. 190
mattress length cm. 190

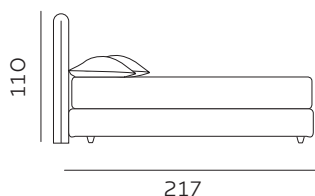

217
materasso lungh. cm. 200
mattress length cm. 200

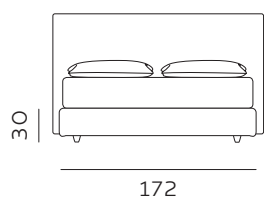

172
materasso largh. cm. 153
mattress width cm. 153

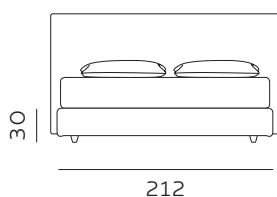

212
materasso largh. cm. 193
mattress width cm. 193

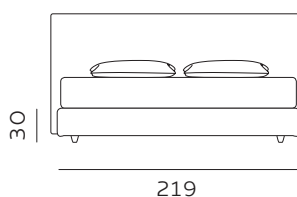

219
materasso largh. cm. 200
mattress width cm. 200

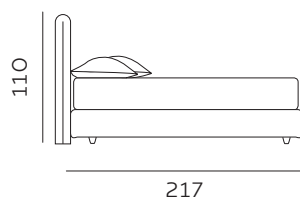

217
materasso lungh. cm. 200
mattress length cm. 200

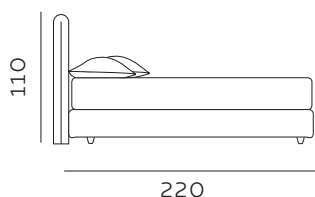

220
materasso lungh. cm. 203
mattress length cm. 203

H. 22 BOX CONTENITORE STORAGE BOX

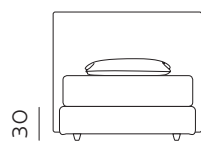

99

materasso largh. cm. 80
mattress width cm. 80

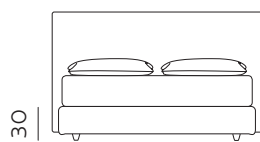

139

materasso largh. cm. 120
mattress width cm. 120

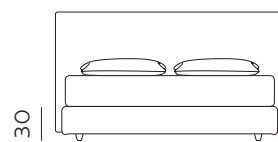

179

materasso largh. cm. 160
mattress width cm. 160

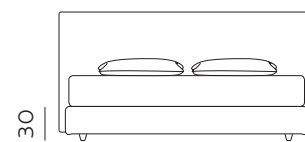

199

materasso largh. cm. 180
mattress width cm. 180

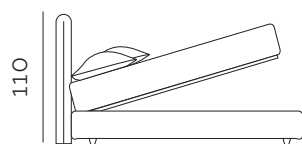

207

materasso lungh. cm. 190
mattress length cm. 190

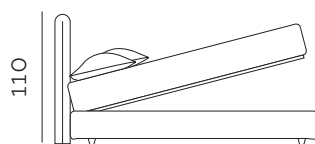

217

materasso lungh. cm. 200
mattress length cm. 200

62

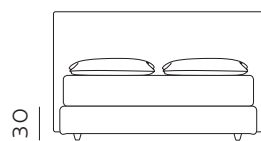

172

materasso largh. cm. 153
mattress width cm. 153

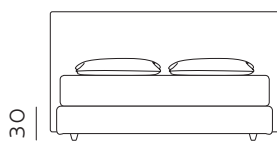

212

materasso largh. cm. 193
mattress width cm. 193

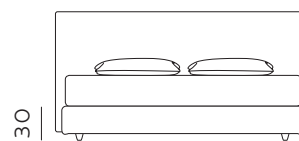

219

materasso largh. cm. 200
mattress width cm. 200

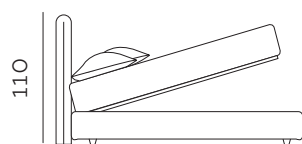

217

materasso lungh. cm. 200
mattress length cm. 200

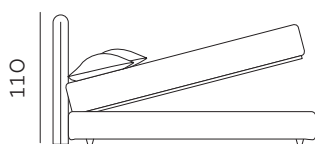

220

materasso lungh. cm. 203
mattress length cm. 203

RETE DI SERIE per BOX CONTENITORE – Standard o Easy Up – Struttura tubolare in acciaio verniciato a polveri e piano rete doppia campata con 14 listelle in multistrato di faggio misura 68x8 mm. (68x12 mm. nella versione 120) - supporto doghe singolo fisso in nylon anticigolio. Per eventuali richieste di sostituzione della rete di serie con modello alternativo richiedere fattibilità e preventivo all'ufficio vendite. / STANDAR BASE for STORAGE BOX– Standard or Easy Up - Tubular structure in powder-coated steel and a double-span slatted base with 14 beech plywood slats measuring 68x8 mm. (68x12 mm. for the 120 version) - fixed single slat supports in anti-squeak nylon. For any requests to replace the standard base with an alternative model, please request feasibility and quotation from the sales department.

PIEDINI PER GIROLETTO h. 22 e 28
FEET FOR BED FRAME h. 22 and 28

Sagomato h. 8 / Shaped h. 8

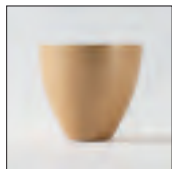

naturale
natural



wengé
wenge



nero laccato
lacquered black

**PIEDINO DI SERIE
PER GIROLETTO h. 22**
*STANDARD FEET
FOR BED FRAME h. 22*

Conico h. 8 / Conical h. 8



nero laccato
lacquered black

**PIEDINO DI SERIE
PER GIROLETTO h. 28**
*STANDARD FEET
FOR BED FRAME h. 28*

Cilindro h. 4 / Cylinder h. 4



nero laccato
lacquered black

Conico h. 8 / Conical h. 8



naturale
natural



rovere sbiancato
bleached oak



wengé
wenge



noce canaletto
canaletto walnut

Piramide h. 8 / Pyramid h. 8



naturale
natural



rovere sbiancato
bleached oak



wengé
wenge



nero laccato
lacquered black

Trapezio h. 8 / Trapezium h. 8



naturale
natural



nero laccato
lacquered black

Permette il passaggio del robot aspirapolvere
It allows passage for the robot vacuum cleaner



In fase di ordine deve essere specificata la
finitura del piedino laddove richiesto. / *Please*
specify foot finish when ordering if required.

Istruzioni di montaggio, vedi pag. 120
Assembly instructions, see page 120

Cartella tessuti, vedi pag 130
Fabric samples, see page 130

Listino prezzi, vedi pag 36
Price List, see page 36

H. 15

GIROLETTO
BED FRAME

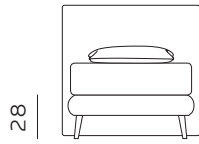

99

materasso largh. cm. 80
mattress width cm. 80

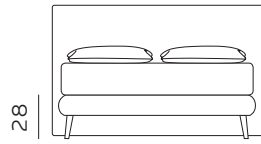

139

materasso largh. cm. 120
mattress width cm. 120

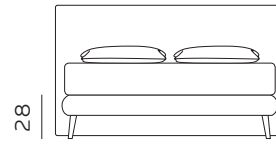

179

materasso largh. cm. 160
mattress width cm. 160

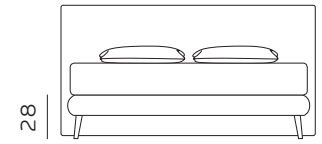

199

materasso largh. cm. 180
mattress width cm. 180

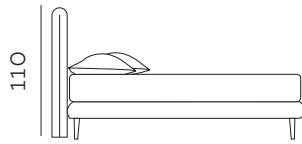

207

materasso lungh. cm. 190
mattress length cm. 190

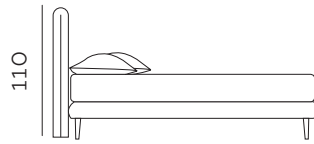

217

materasso lungh. cm. 200
mattress length cm. 200

64

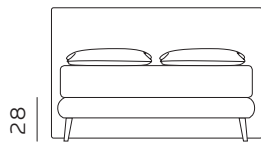

172

materasso largh. cm. 153
mattress width cm. 153

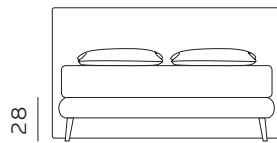

212

materasso largh. cm. 193
mattress width cm. 193

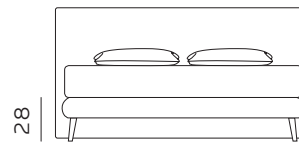

219

materasso largh. cm. 200
mattress width cm. 200

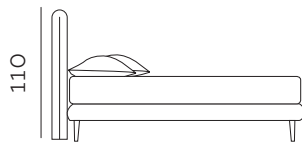

217

materasso lungh. cm. 200
mattress length cm. 200

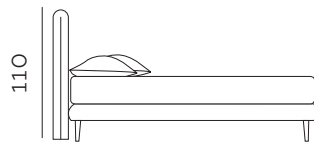

220

materasso lungh. cm. 203
mattress length cm. 203

PIEDINI / FEET

Conico h. 13 / Conical h. 13



naturale
natural



rovere sbiancato
bleached oak



wengé
wenge



noce canaletto
canaletto walnut

PIEDINO DI SERIE
PER GIROLETTO h. 15
STANDARD FEET
FOR BED FRAME h. 15

Conico h. 13 / Conical h. 13



nero laccato
lacquered black

Metallo angolare h. 13 / Angular metal h. 13



metallo nero
black metal

Permette il passaggio del robot aspirapolvere
It allows passage for the robot vacuum cleaner



In fase di ordine deve essere specificata la
finitura del piedino laddove richiesto. / Please
specify foot finish when ordering if required.

Istruzioni di montaggio, vedi pag. 122
Assembly instructions, see page 122

Cartella tessuti, vedi pag 130
Fabric samples, see page 130

Listino prezzi, vedi pag 36
Price List, see page 36

FREYA

Scheda tecnica / Technical data

Il letto Freya è un letto imbottito e sfoderabile disponibile in diverse misure. Questo modello può essere realizzato in tutte e tre le altezze di giroletto: 28 cm. anche con box standard o versione easy-up con piedini di altezza 8 cm. e di serie di 4 cm., 22 cm. anche box contenitore e piedini di altezza 8 cm., 15 cm. con piedino conico o angolare di altezza 13 cm.

Freya is an upholstered and removable bed available in different sizes. This model can be manufactured in three bed frame heights: 28 cm. available with standard box or easy-up box system with 8 cm. feet or standard feet of 4 cm.; 22 cm., with storage box and 8 cm. feet, and 15 cm. with cone or angular 13 cm. feet.



Immagine in alto
testiera / giroletto: Now or Never 03
piedini: conico nero laccato h. 13 cm.
Immagine in basso
testiera / giroletto: Miami 48
piedini: cilindro nero laccato h. 4 cm.

66

Image above
headboard / bed frame: Now or Never 03
feet: black lacquered conical h. 13 cm.
Image below
headboard / bed frame: Miami 48
feet: black lacquered cylinder h. 4 cm.



igiene sicura sfoderabile
e lavabile / safe hygiene
removable and washable



DIMENSIONI DISPONIBILI / AVAILABLE SIZES

piazza e mezza 120x190 / 120x200 cm.
matrimoniale 160x190 / 160x200 cm.
matrimoniale xl 180x190 / 180x200 cm.
queen 153x203 cm.
king 193x203 cm.
matrimoniale xxl 200x200 cm.

*three-quarter size 120x190 / 120x200 cm.
double bed size 160x190 / 160x200 cm.
double bed xl 180x190 / 180x200 cm.
queen 153x203 cm.
king 193x203 cm.
double bed xxl 200x200 cm.*

H. 28 GIROLETTO BED FRAME

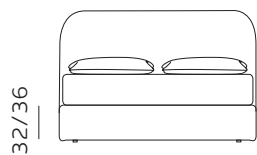

135

materasso largh. cm. 120
mattress width cm. 120

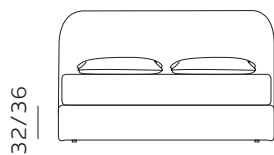

175

materasso largh. cm. 160
mattress width cm. 160

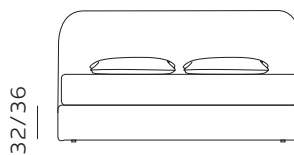

195

materasso largh. cm. 180
mattress width cm. 180

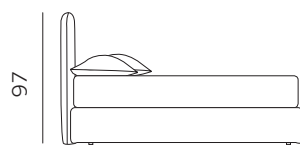

206

materasso lungh. cm. 190
mattress length cm. 190

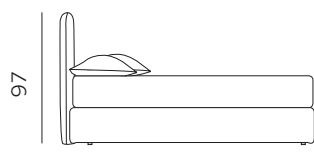

216

materasso lungh. cm. 200
mattress length cm. 200

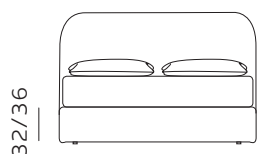

168

materasso largh. cm. 153
mattress width cm. 153

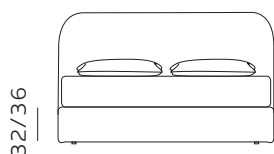

208

materasso largh. cm. 193
mattress width cm. 193

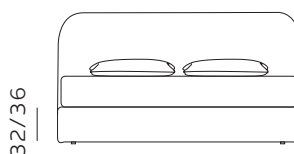

215

materasso largh. cm. 200
mattress width cm. 200

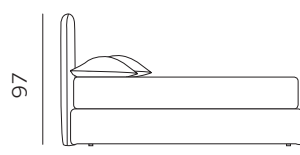

216

materasso lungh. cm. 200
mattress length cm. 200

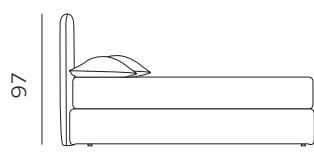

219

materasso lungh. cm. 203
mattress length cm. 203

H. 28 BOX CONTENITORE / BOX CONTENITORE EASY-UP STORAGE BOX / STORAGE BOX EASY-UP

Il box contenitore standard e box contenitore easy-up sono disponibili per giroletto standard e sagomato.
The standard storage box and easy-up storage box are available for both standard and shaped bed frames.

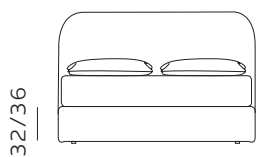

135

materasso largh. cm. 120
mattress width cm. 120

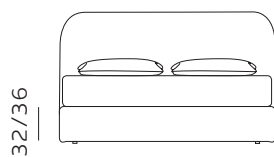

175

materasso largh. cm. 160
mattress width cm. 160

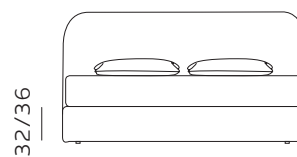

195

materasso largh. cm. 180
mattress width cm. 180

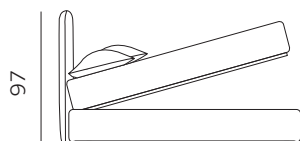

206

materasso largh. cm. 190
mattress length cm. 190

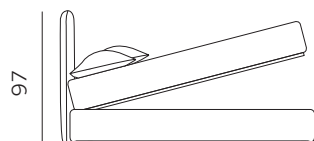

216

materasso largh. cm. 200
mattress length cm. 200

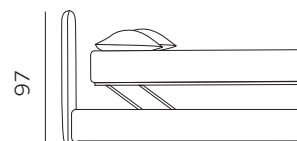

206

materasso largh. cm. 190
mattress length cm. 190

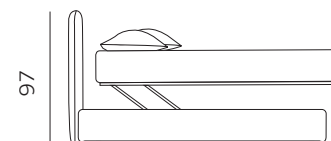

216

materasso largh. cm. 200
mattress length cm. 200

68

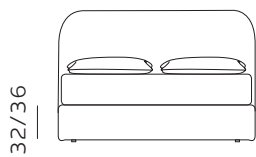

168

materasso largh. cm. 153
mattress width cm. 153

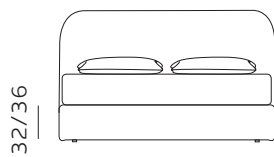

208

materasso largh. cm. 193
mattress width cm. 193

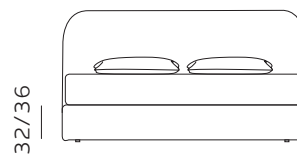

215

materasso largh. cm. 200
mattress width cm. 200

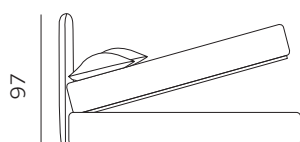

216

materasso largh. cm. 200
mattress length cm. 200

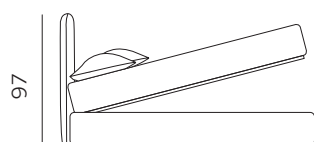

219

materasso largh. cm. 203
mattress length cm. 203

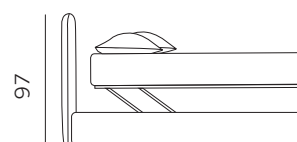

216

materasso largh. cm. 200
mattress length cm. 200

Per le misure Queen e King non è prevista la versione box contenitore easy-up. / The easy-up box storage version is not available for Queen and King sizes.

RETE DI SERIE per BOX CONTENITORE – Standard o Easy Up - Struttura tubolare in acciaio verniciato a polveri e piano rete doppia campata con 14 listelle in multistrato di faggio misura 68x8 mm. (68x12 mm. nella versione 120) - supporto doghe singolo fisso in nylon anticigolio. Per eventuali richieste di sostituzione della rete di serie con modello alternativo richiedere fattibilità e preventivo all'ufficio vendite. / STANDAR BASE for STORAGE BOX– Standard or Easy Up - Tubular structure in powder-coated steel and a double-span slatted base with 14 beech plywood slats measuring 68x8 mm. (68x12 mm. for the 120 version) - fixed single slat supports in anti-squeak nylon. For any requests to replace the standard base with an alternative model, please request feasibility and quotation from the sales department.

H. 22 GIROLETTO BED FRAME

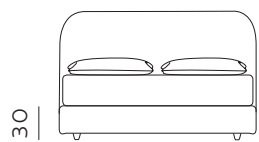

135

materasso largh. cm. 120
mattress width cm. 120

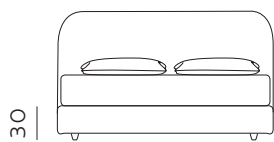

175

materasso largh. cm. 160
mattress width cm. 160

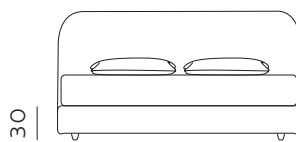

195

materasso largh. cm. 180
mattress width cm. 180

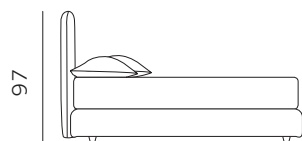

206

materasso lungh. cm. 190
mattress length cm. 190

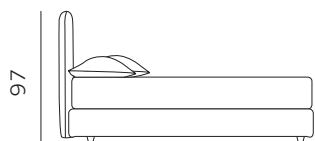

216

materasso lungh. cm. 200
mattress length cm. 200

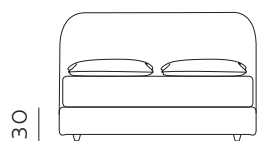

168

materasso largh. cm. 153
mattress width cm. 153

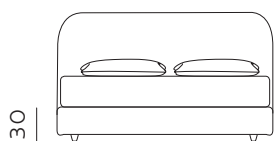

208

materasso largh. cm. 193
mattress width cm. 193

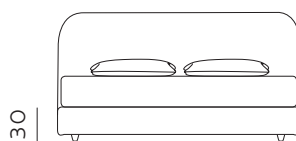

215

materasso largh. cm. 200
mattress width cm. 200

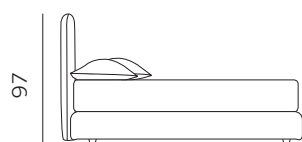

216

materasso lungh. cm. 200
mattress length cm. 200

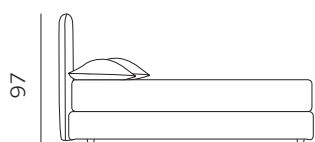

219

materasso lungh. cm. 203
mattress length cm. 203

H. 22 BOX CONTENITORE STORAGE BOX

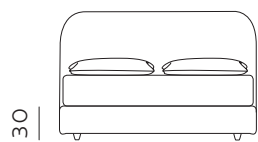

135

materasso largh. cm. 120
mattress width cm. 120

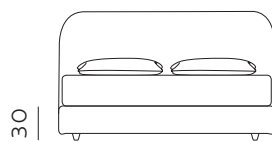

175

materasso largh. cm. 160
mattress width cm. 160

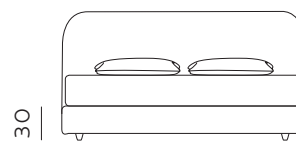

195

materasso largh. cm. 180
mattress width cm. 180

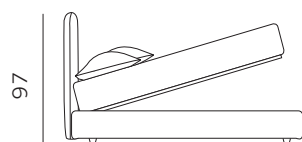

206

materasso lungh. cm. 190
mattress length cm. 190

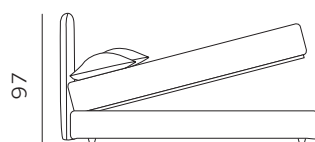

216

materasso lungh. cm. 200
mattress length cm. 200

70

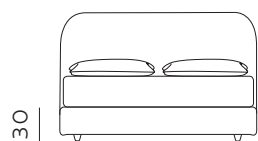

168

materasso largh. cm. 153
mattress width cm. 153

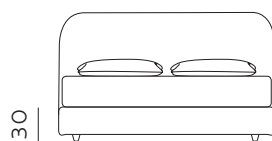

208

materasso largh. cm. 193
mattress width cm. 193

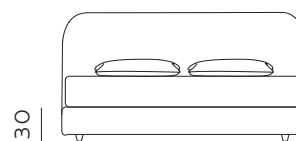

215

materasso largh. cm. 200
mattress width cm. 200

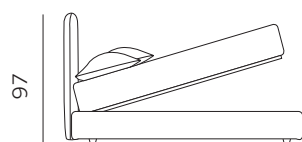

216

materasso lungh. cm. 200
mattress length cm. 200

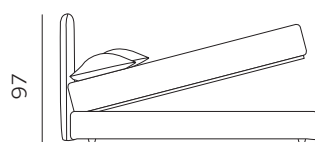

219

materasso lungh. cm. 203
mattress length cm. 203

RETE DI SERIE per BOX CONTENITORE – Standard o Easy Up – Struttura tubolare in acciaio verniciato a polveri e piano rete doppia campata con 14 listelle in multistrato di faggio misura 68x8 mm. (68x12 mm. nella versione 120) - supporto doghe singolo fisso in nylon anticigolio. Per eventuali richieste di sostituzione della rete di serie con modello alternativo richiedere fattibilità e preventivo all'ufficio vendite. / STANDAR BASE for STORAGE BOX– Standard or Easy Up - Tubular structure in powder-coated steel and a double-span slatted base with 14 beech plywood slats measuring 68x8 mm. (68x12 mm. for the 120 version) - fixed single slat supports in anti-squeak nylon. For any requests to replace the standard base with an alternative model, please request feasibility and quotation from the sales department.

PIEDINI PER GIROLETTO h. 22 e 28
FEET FOR BED FRAME h. 22 and 28

Sagomato h. 8 / Shaped h. 8



naturale
natural



wengé
wenge



nero laccato
lacquered black

**PIEDINO DI SERIE
 PER GIROLETTO h. 22
 STANDARD FEET
 FOR BED FRAME h. 22**

Conico h. 8 / Conical h. 8



nero laccato
lacquered black

**PIEDINO DI SERIE
 PER GIROLETTO h. 28
 STANDARD FEET
 FOR BED FRAME h. 28**

Cilindro h. 4 / Cylinder h. 4



nero laccato
lacquered black

Conico h. 8 / Conical h. 8



naturale
natural



rovere sbiancato
bleached oak



wengé
wenge



noce canaletto
canaletto walnut

Piramide h. 8 / Pyramid h. 8



naturale
natural



rovere sbiancato
bleached oak



wengé
wenge



nero laccato
lacquered black

Trapezio h. 8 / Trapezium h. 8



naturale
natural



nero laccato
lacquered black

Permette il passaggio del robot aspirapolvere
 It allows passage for the robot vacuum cleaner



In fase di ordine deve essere specificata la
 finitura del piedino laddove richiesto. / Please
 specify foot finish when ordering if required.

Istruzioni di montaggio, vedi pag. 120
 Assembly instructions, see page 120

Cartella tessuti, vedi pag 130
 Fabric samples, see page 130

Listino prezzi, vedi pag 40
 Price List, see page 40

H. 15

GIROLETTO
BED FRAME

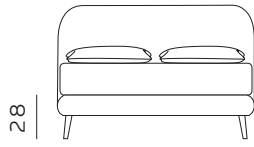

135

materasso largh. cm. 120
mattress width cm. 120

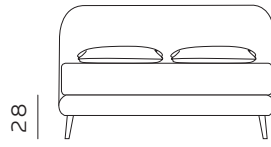

175

materasso largh. cm. 160
mattress width cm. 160

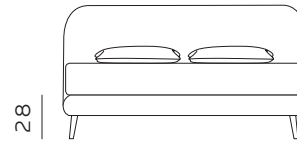

195

materasso largh. cm. 180
mattress width cm. 180

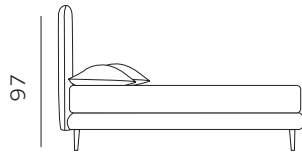

206

materasso lungh. cm. 190
mattress length cm. 190

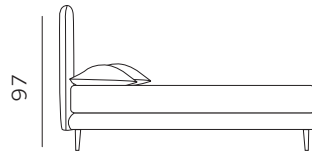

216

materasso lungh. cm. 200
mattress length cm. 200

72

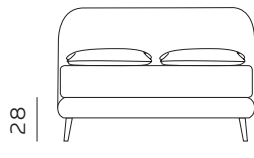

168

materasso largh. cm. 153
mattress width cm. 153

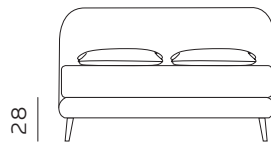

208

materasso largh. cm. 193
mattress width cm. 193

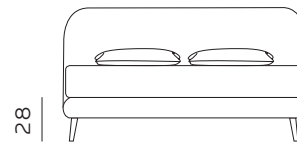

215

materasso largh. cm. 200
mattress width cm. 200

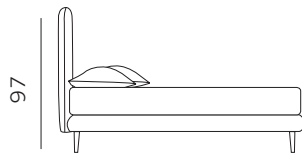

216

materasso lungh. cm. 200
mattress length cm. 200

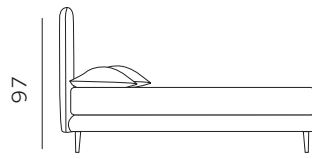

219

materasso lungh. cm. 203
mattress length cm. 203

PIEDINI / FEET

Conico h. 13 / Conical h. 13

naturale
naturalrovere sbiancato
bleached oakwengé
wengenoce canaletto
canaletto walnutPIEDINO DI SERIE
PER GIROLETTO h. 15
STANDARD FEET
FOR BED FRAME h. 15

Conico h. 13 / Conical h. 13

nero laccato
lacquered black

Metallo angolare h. 13 / Angular metal h. 13

metallo nero
black metalPermette il passaggio del robot aspirapolvere
It allows passage for the robot vacuum cleanerIn fase di ordine deve essere specificata la
finitura del piedino laddove richiesto. / Please
specify foot finish when ordering if required.Istruzioni di montaggio, vedi pag. 122
Assembly instructions, see page 122Cartella tessuti, vedi pag 130
Fabric samples, see page 130Listino prezzi, vedi pag 40
Price List, see page 40

VENTURA

Scheda tecnica / Technical data

Il letto Ventura è un letto imbottito sfoderabile disponibile in tutte le dimensioni e realizzabile in due diverse misure di giroletto: 28 cm., anche in versione sagomato, con box standard o easy-up con piedini di altezza 8 cm. e di serie di 4 cm., 22 cm. anche con box contenitore e piedini di altezza 8 cm.

The Ventura bed is an upholstered, removable bed available in all sizes and can be realised with two different bed frame heights: 28 cm., available in shaped version, with a standard or easy-up storage box and 8 cm. feet or standard 4 cm. feet, 22 cm., available with storage box and 8 cm. feet.



Immagine in alto
testiera / giroletto: Cruise Melange 02
piedini: conico nero laccato h. 8 cm.
Immagine in basso
testiera / giroletto: Toledo 45
piedini: cilindro nero laccato h. 4 cm.

Image above
headboard / bed frame: Cruise Melange 02
feet: black lacquered conical h. 8 cm.
Image below
headboard / bed frame: Toledo 45
feet: black lacquered cylinder h. 4 cm.



igiene sicura sfoderabile
e lavabile / safe hygiene
removable and washable



74



DIMENSIONI DISPONIBILI / AVAILABLE SIZES

singolo 80x190 / 80x200 cm.
piazza e mezza 120x190 / 120x200 cm.
matrimoniale 160x190 / 160x200 cm.
matrimoniale xl 180x190 / 180x200 cm.
queen 153x203 cm.
king 193x203 cm.
matrimoniale xxl 200x200 cm.

single 80x190 / 80x200 cm.
three-quarter size 120x190 / 120x200 cm.
double bed size 160x190 / 160x200 cm.
double bed xl 180x190 / 180x200 cm.
queen 153x203 cm.
king 193x203 cm.
double bed xxl 200x200 cm.

H. 28 GIROLETTO / GIROLETTO SAGOMATO

BED FRAME / SHAPED BED FRAME

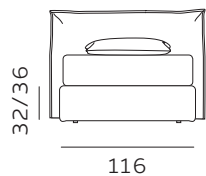

116
materasso largh. cm. 80
mattress width cm. 80

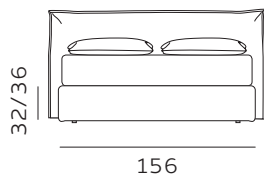

156
materasso largh. cm. 120
mattress width cm. 120

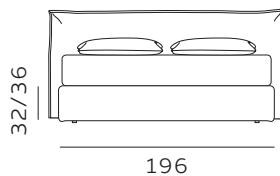

196
materasso largh. cm. 160
mattress width cm. 160

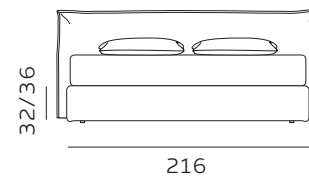

216
materasso largh. cm. 180
mattress width cm. 180

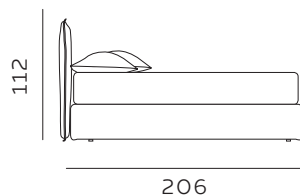

206
materasso lungh. cm. 190
mattress length cm. 190

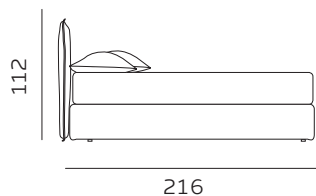

216
materasso lungh. cm. 200
mattress length cm. 200

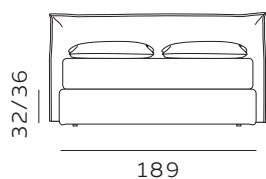

189
materasso largh. cm. 153
mattress width cm. 153

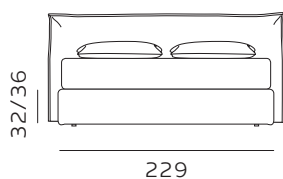

229
materasso largh. cm. 193
mattress width cm. 193

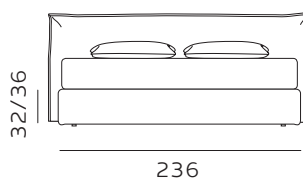

236
materasso largh. cm. 200
mattress width cm. 200

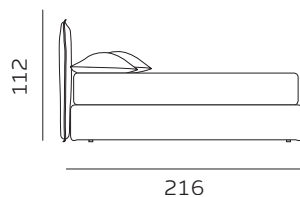

216
materasso lungh. cm. 200
mattress length cm. 200

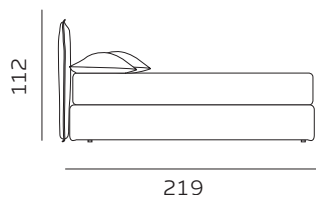

219
materasso lungh. cm. 203
mattress length cm. 203

H. 28 BOX CONTENITORE / BOX CONTENITORE EASY-UP STORAGE BOX / STORAGE BOX EASY-UP

Il box contenitore standard e box contenitore easy-up sono disponibili per giroletto standard e sagomato.
The standard storage box and easy-up storage box are available for both standard and shaped bed frames.

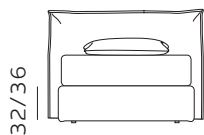

116

materasso largh. cm. 80
mattress width cm. 80

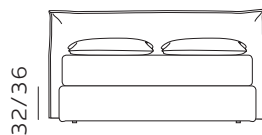

156

materasso largh. cm. 120
mattress width cm. 120

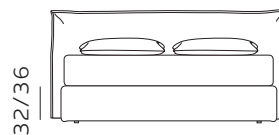

196

materasso largh. cm. 160
mattress width cm. 160

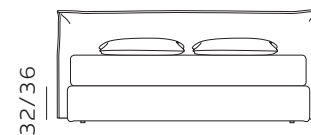

216

materasso largh. cm. 180
mattress width cm. 180

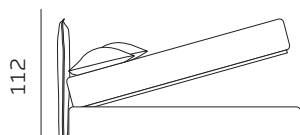

206

materasso largh. cm. 190
mattress length cm. 190

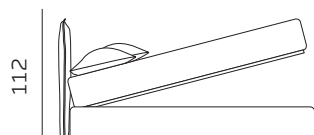

216

materasso largh. cm. 200
mattress length cm. 200

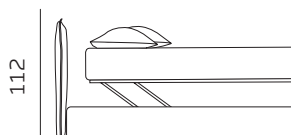

206

materasso largh. cm. 190
mattress length cm. 190

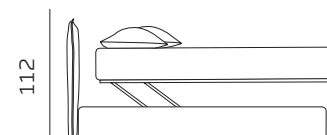

216

materasso largh. cm. 200
mattress length cm. 200

76

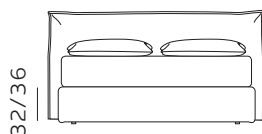

189

materasso largh. cm. 153
mattress width cm. 153

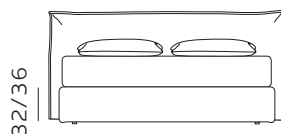

229

materasso largh. cm. 193
mattress width cm. 193

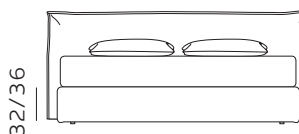

236

materasso largh. cm. 200
mattress width cm. 200

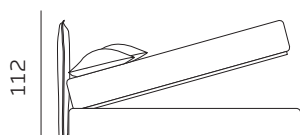

216

materasso largh. cm. 200
mattress length cm. 200

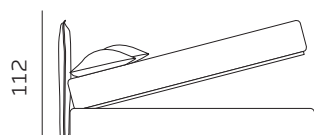

219

materasso largh. cm. 203
mattress length cm. 203

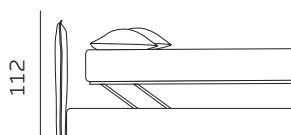

216

materasso largh. cm. 200
mattress length cm. 200

Per le misure Queen e King non è prevista la versione box contenitore easy-up. / The easy-up box storage version is not available for Queen and King sizes.

RETE DI SERIE per BOX CONTENITORE – Standard o Easy Up - Struttura tubolare in acciaio verniciato a polveri e piano rete doppia campata con 14 listelle in multistrato di faggio misura 68x8 mm. (68x12 mm. nella versione 120) - supporto doghe singolo fisso in nylon anticigolio. Per eventuali richieste di sostituzione della rete di serie con modello alternativo richiedere fattibilità e preventivo all'ufficio vendite. / STANDAR BASE for STORAGE BOX– Standard or Easy Up - Tubular structure in powder-coated steel and a double-span slatted base with 14 beech plywood slats measuring 68x8 mm. (68x12 mm. for the 120 version) - fixed single slat supports in anti-squeak nylon. For any requests to replace the standard base with an alternative model, please request feasibility and quotation from the sales department.

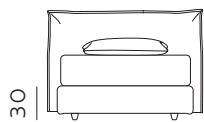

116

materasso largh. cm. 80
mattress width cm. 80

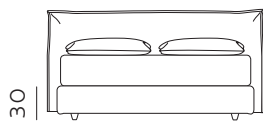

156

materasso largh. cm. 120
mattress width cm. 120

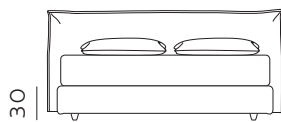

196

materasso largh. cm. 160
mattress width cm. 160

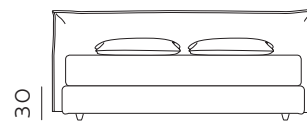

216

materasso largh. cm. 180
mattress width cm. 180

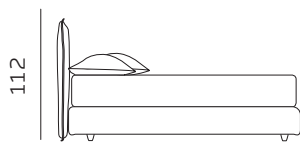

206

materasso lungh. cm. 190
mattress length cm. 190

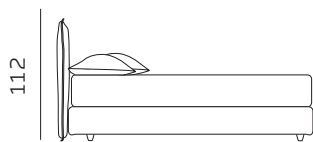

216

materasso lungh. cm. 200
mattress length cm. 200

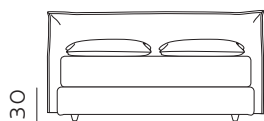

189

materasso largh. cm. 153
mattress width cm. 153

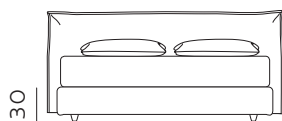

229

materasso largh. cm. 193
mattress width cm. 193

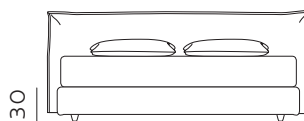

236

materasso largh. cm. 200
mattress width cm. 200

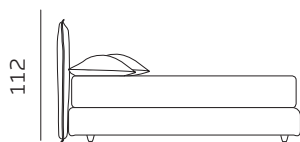

216

materasso lungh. cm. 200
mattress length cm. 200

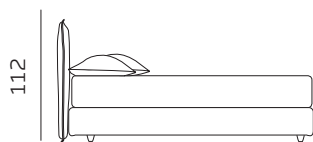

219

materasso lungh. cm. 203
mattress length cm. 203

H. 22 BOX CONTENITORE STORAGE BOX

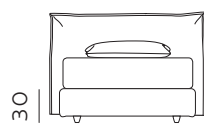

116

materasso largh. cm. 80
mattress width cm. 80

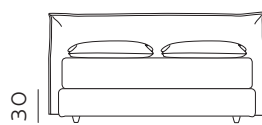

156

materasso largh. cm. 120
mattress width cm. 120

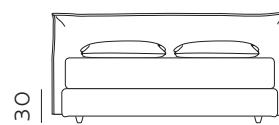

196

materasso largh. cm. 160
mattress width cm. 160

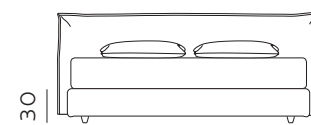

216

materasso largh. cm. 180
mattress width cm. 180

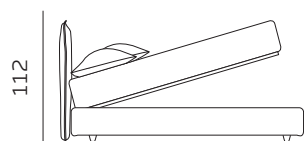

206

materasso lungh. cm. 190
mattress length cm. 190

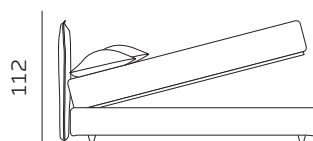

216

materasso lungh. cm. 200
mattress length cm. 200

78

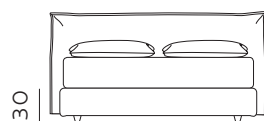

189

materasso largh. cm. 153
mattress width cm. 153

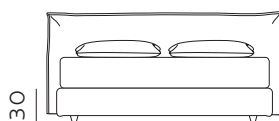

229

materasso largh. cm. 193
mattress width cm. 193

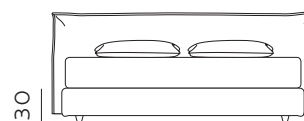

236

materasso largh. cm. 200
mattress width cm. 200

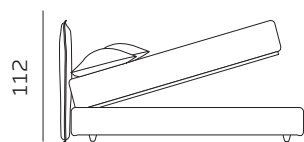

216

materasso lungh. cm. 200
mattress length cm. 200

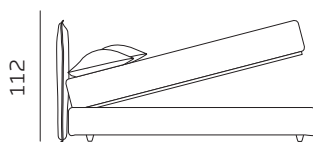

219

materasso lungh. cm. 203
mattress length cm. 203

RETE DI SERIE per BOX CONTENITORE – Standard o Easy Up – Struttura tubolare in acciaio verniciato a polveri e piano rete doppia campata con 14 listelle in multistrato di faggio misura 68x8 mm. (68x12 mm. nella versione 120) - supporto doghe singolo fisso in nylon anticigolio. Per eventuali richieste di sostituzione della rete di serie con modello alternativo richiedere fattibilità e preventivo all'ufficio vendite. / STANDAR BASE for STORAGE BOX– Standard or Easy Up - Tubular structure in powder-coated steel and a double-span slatted base with 14 beech plywood slats measuring 68x8 mm. (68x12 mm. for the 120 version) - fixed single slat supports in anti-squeak nylon. For any requests to replace the standard base with an alternative model, please request feasibility and quotation from the sales department.

PIEDINI PER GIROLETTO h. 22 e 28
FEET FOR BED FRAME h. 22 and 28

Sagomato h. 8 / Shaped h. 8



naturale
natural



wengé
wenge



nero laccato
lacquered black

**PIEDINO DI SERIE
 PER GIROLETTO h. 22
 STANDARD FEET
 FOR BED FRAME h. 22**

Conico h. 8 / Conical h. 8



nero laccato
lacquered black

**PIEDINO DI SERIE
 PER GIROLETTO h. 28
 STANDARD FEET
 FOR BED FRAME h. 28**

Cilindro h. 4 / Cylinder h. 4



nero laccato
lacquered black

Conico h. 8 / Conical h. 8



naturale
natural



rovere sbiancato
bleached oak



wengé
wenge



noce canaletto
canaletto walnut

Piramide h. 8 / Pyramid h. 8



naturale
natural



rovere sbiancato
bleached oak



wengé
wenge



nero laccato
lacquered black

Trapezio h. 8 / Trapezium h. 8



naturale
natural



nero laccato
lacquered black

Permette il passaggio del robot aspirapolvere
 It allows passage for the robot vacuum cleaner



In fase di ordine deve essere specificata la
 finitura del piedino laddove richiesto. / Please
 specify foot finish when ordering if required.

Istruzioni di montaggio, vedi pag. 120
 Assembly instructions, see page 120

Cartella tessuti, vedi pag 130
 Fabric samples, see page 130

Listino prezzi, vedi pag 44
 Price List, see page 44

VENTURA MAXI

Scheda tecnica / Technical data

Il Ventura Maxi è un letto imbottito sfoderabile disponibile in diverse dimensioni. Questo modello è realizzabile in due diverse altezze di giroletto: 28 cm., anche in versione sagomato, sia con box standard che con sistema easy-up, e 22 cm., anche con box contenitore. Il letto Ventura Maxi può essere personalizzato con piedini dalle diverse tipologie e finiture: piedini di altezza 8 cm. e di serie di 4 cm. per il giroletto da 28 cm., piedini di altezza 8 cm. per il giroletto da 22 cm.

The Ventura Maxi bed is an upholstered, removable bed available in different sizes. This model can be made in two different bed frame heights: 28 cm., also in a shaped version, available with standard storage box and easy-up box system, and 22 cm., available with storage box. Ventura Maxi can be customized with feet of different types, height and finishes: 8 cm. feet and standard 4 cm. feet for the 28 cm. bed frame, 8 cm. feet for the 22 cm. bed frame.

Immagine in alto
testiera / giroletto: Pop 405
piedini: cilindro nero laccato h. 4 cm.
Immagine in basso
testiera: Cashmere 500
Giroletto: Solemio 107
piedini: conico naturale h. 8 cm.

80 *Image above
headboard / bed frame: Pop 405
feet: black lacquered cylinder h. 4 cm.
Image below
headboard: Cashmere 500
bed frame: Solemio 107
feet: natural conical h. 8 cm.*



igiene sicura sfoderabile
e lavabile / safe hygiene
removable and washable



DIMENSIONI DISPONIBILI / AVAILABLE SIZES

matrimoniale 160x190 / 160x200 cm.
matrimoniale xl 180x190 / 180x200 cm.
queen 153x203 cm.
king 193x203 cm.
matrimoniale xxl 200x200 cm.

*double bed 160x190 / 160x200 cm.
double bed xl 180x190 / 180x200 cm.
queen 153x203 cm.
king 193x203 cm.
double bed xxl 200x200 cm.*

H. 28 GIROLETTO / GIROLETTO SAGOMATO

BED FRAME / SHAPED BED FRAME

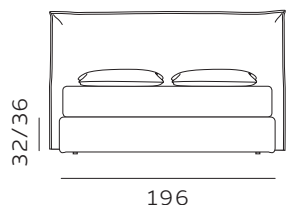

196
materasso largh. cm. 160
mattress width cm. 160

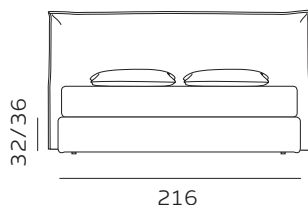

216
materasso largh. cm. 180
mattress width cm. 180

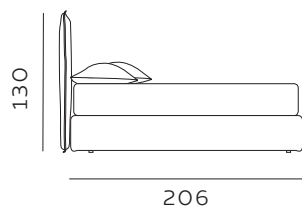

206
materasso lungh. cm. 190
mattress length cm. 190

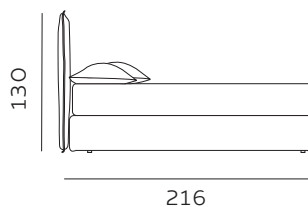

216
materasso lungh. cm. 200
mattress length cm. 200

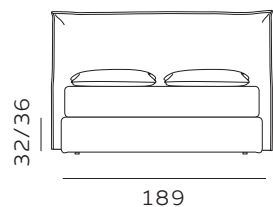

189
materasso largh. cm. 153
mattress width cm. 153

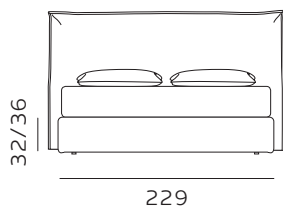

229
materasso largh. cm. 193
mattress width cm. 193

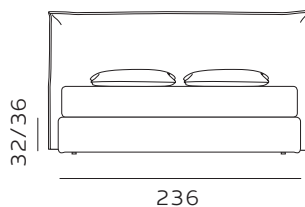

236
materasso largh. cm. 200
mattress width cm. 200

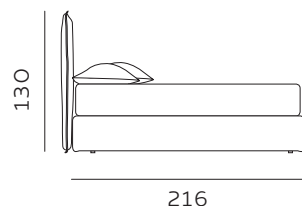

216
materasso lungh. cm. 200
mattress length cm. 200

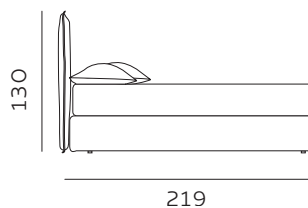

219
materasso lungh. cm. 203
mattress length cm. 203

H. 28 BOX CONTENITORE / BOX CONTENITORE EASY-UP STORAGE BOX / STORAGE BOX EASY-UP

Il box contenitore standard e box contenitore easy-up sono disponibili per giroletto standard e sagomato.
The standard storage box and easy-up storage box are available for both standard and shaped bed frames.

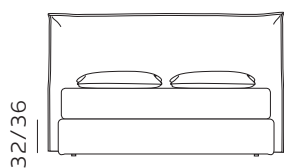

196

materasso largh. cm. 160
mattress width cm. 160

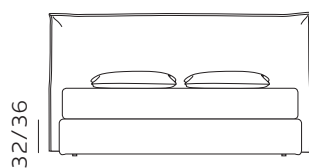

216

materasso largh. cm. 180
mattress width cm. 180

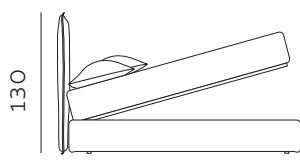

206

materasso lungh. cm. 190
mattress length cm. 190

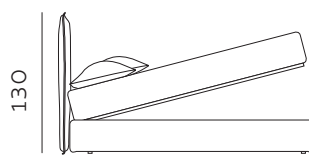

216

materasso lungh. cm. 200
mattress length cm. 200

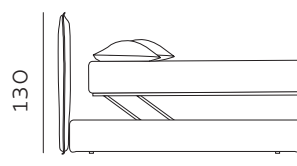

206

materasso lungh. cm. 190
mattress length cm. 190

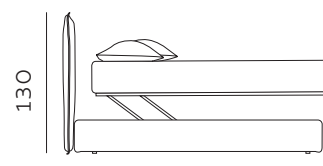

216

materasso lungh. cm. 200
mattress length cm. 200

82

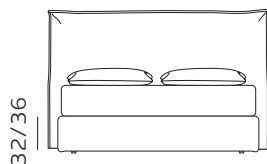

189

materasso largh. cm. 153
mattress width cm. 153

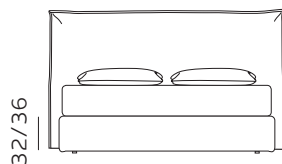

229

materasso largh. cm. 193
mattress width cm. 193

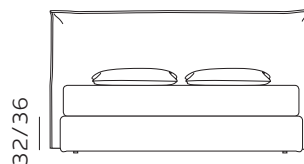

236

materasso largh. cm. 200
mattress width cm. 200

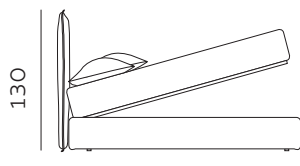

216

materasso lungh. cm. 200
mattress length cm. 200

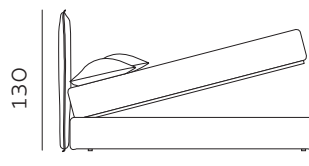

219

materasso lungh. cm. 203
mattress length cm. 203

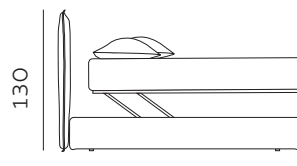

216

materasso lungh. cm. 200
mattress length cm. 200

Per le misure Queen e King non è prevista la versione box contenitore easy-up. / The easy-up box storage version is not available for Queen and King sizes.

RETE DI SERIE per BOX CONTENITORE – Standard o Easy Up - Struttura tubolare in acciaio verniciato a polveri e piano rete doppia campata con 14 listelle in multistrato di faggio misura 68x8 mm. (68x12 mm. nella versione 120) - supporto doghe singolo fisso in nylon anticigolio. Per eventuali richieste di sostituzione della rete di serie con modello alternativo richiedere fattibilità e preventivo all'ufficio vendite. / STANDAR BASE for STORAGE BOX– Standard or Easy Up - Tubular structure in powder-coated steel and a double-span slatted base with 14 beech plywood slats measuring 68x8 mm. (68x12 mm. for the 120 version) - fixed single slat supports in anti-squeak nylon. For any requests to replace the standard base with an alternative model, please request feasibility and quotation from the sales department.

H. 22 GIROLETTO BED FRAME

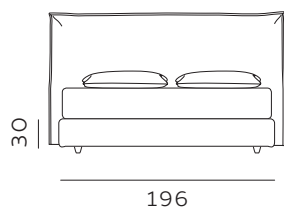

materasso largh. cm. 160
mattress width cm. 160

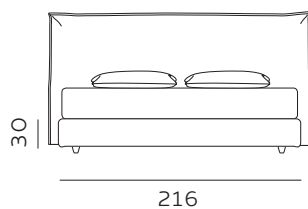

materasso largh. cm. 180
mattress width cm. 180

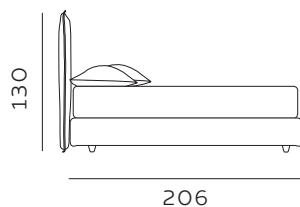

materasso lungh. cm. 190
mattress length cm. 190

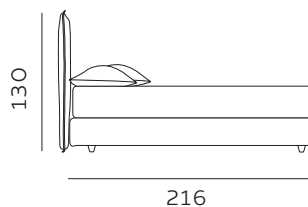

materasso lungh. cm. 200
mattress length cm. 200

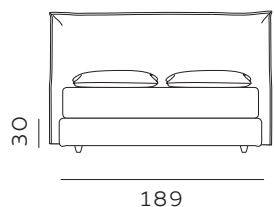

materasso largh. cm. 153
mattress width cm. 153

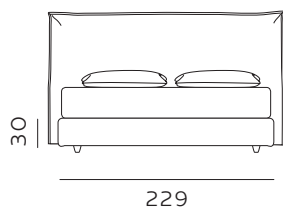

materasso largh. cm. 193
mattress width cm. 193

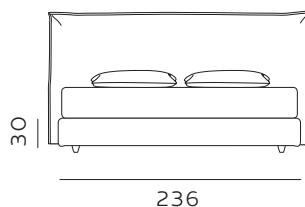

materasso largh. cm. 200
mattress width cm. 200

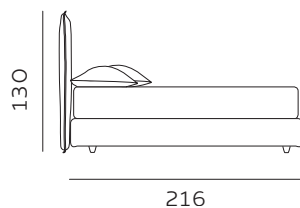

materasso lungh. cm. 200
mattress length cm. 200

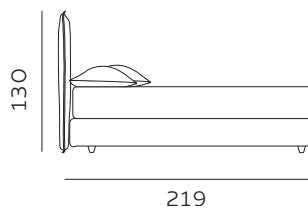

materasso lungh. cm. 203
mattress length cm. 203

H. 22 BOX CONTENITORE STORAGE BOX

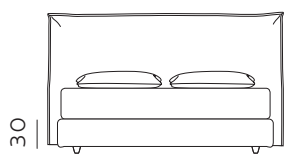

196

materasso largh. cm. 160
mattress width cm. 160

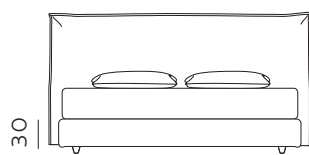

216

materasso largh. cm. 180
mattress width cm. 180

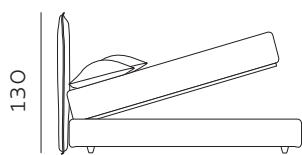

206

materasso lungh. cm. 190
mattress length cm. 190

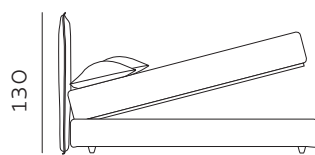

216

materasso lungh. cm. 200
mattress length cm. 200

84

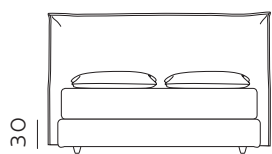

189

materasso largh. cm. 153
mattress width cm. 153

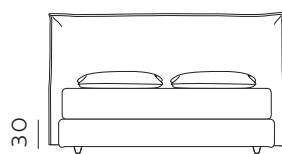

229

materasso largh. cm. 193
mattress width cm. 193

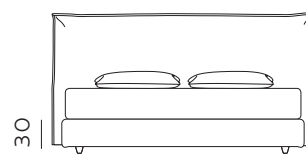

236

materasso largh. cm. 200
mattress width cm. 200

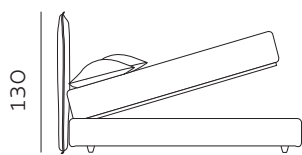

216

materasso lungh. cm. 200
mattress length cm. 200

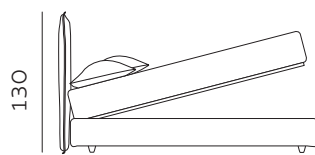

219

materasso lungh. cm. 203
mattress length cm. 203

RETE DI SERIE per BOX CONTENITORE – Standard o Easy Up – Struttura tubolare in acciaio verniciato a polveri e piano rete doppia campata con 14 listelle in multistrato di faggio misura 68x8 mm. (68x12 mm. nella versione 120) - supporto doghe singolo fisso in nylon anticigolio. Per eventuali richieste di sostituzione della rete di serie con modello alternativo richiedere fattibilità e preventivo all'ufficio vendite. / STANDAR BASE for STORAGE BOX– Standard or Easy Up - Tubular structure in powder-coated steel and a double-span slatted base with 14 beech plywood slats measuring 68x8 mm. (68x12 mm. for the 120 version) - fixed single slat supports in anti-squeak nylon. For any requests to replace the standard base with an alternative model, please request feasibility and quotation from the sales department.

PIEDINI PER GIROLETTO h. 22 e 28
FEET FOR BED FRAME h. 22 and 28

Sagomato h. 8 / Shaped h. 8



naturale
natural



wengé
wenge



nero laccato
lacquered black

**PIEDINO DI SERIE
PER GIROLETTO h. 22**
*STANDARD FEET
FOR BED FRAME h. 22*

Conico h. 8 / Conical h. 8



nero laccato
lacquered black

**PIEDINO DI SERIE
PER GIROLETTO h. 28**
*STANDARD FEET
FOR BED FRAME h. 28*

Cilindro h. 4 / Cylinder h. 4



nero laccato
lacquered black

Conico h. 8 / Conical h. 8



naturale
natural



rovere sbiancato
bleached oak



wengé
wenge



noce canaletto
canaletto walnut

Piramide h. 8 / Pyramid h. 8



naturale
natural



rovere sbiancato
bleached oak



wengé
wenge



nero laccato
lacquered black

Trapezio h. 8 / Trapezium h. 8



naturale
natural



nero laccato
lacquered black

Permette il passaggio del robot aspirapolvere
It allows passage for the robot vacuum cleaner



In fase di ordine deve essere specificata la
finitura del piedino laddove richiesto. / *Please*
specify foot finish when ordering if required.

Istruzioni di montaggio, vedi pag. 120
Assembly instructions, see page 120

Cartella tessuti, vedi pag 130
Fabric samples, see page 130

Listino prezzi, vedi pag 48
Price List, see page 48

SOPHIE

Scheda tecnica / Technical data

Sophie è un letto imbottito, trapuntato e con testiera non sfoderabile, disponibile in diverse dimensioni. Questo modello può essere realizzato in due diverse altezze di giroletto: la prima di 28 cm. realizzabile anche con giroletto sagomato, con box standard o easy-up, dotata di piedini di 8 cm. e di serie di 4 cm., la seconda di 22 cm. disponibile con box contenitore e piedini di altezza 8 cm.

Sophie is an upholstered, quilted bed with a non-removable headboard, available in different sizes. This model can be made in two different bed frame heights: 28 cm., available in shaped version, with a standard or easy-up storage box and 8 cm. feet or standard 4 cm. feet, 22 cm., available with storage box and 8 cm. feet.



Immagine in alto
testiera / giroletto: Bombay 26
piedini: cilindro nero laccato h. 4 cm.
Immagine in basso
testiera / giroletto: Oviedo 47
piedini: conico nero laccato h. 8 cm.

86

Image above
headboard / bed frame: Bombay 26
feet: black lacquered cylinder h. 4 cm.
Image below
headboard / bed frame: Oviedo 47
feet: black lacquered conical h. 8 cm.



igiene sicura sfoderabile
e lavabile per giroletto/
safe hygiene removable
and washable for bed
frame



DIMENSIONI DISPONIBILI / AVAILABLE SIZES

piazza e mezza 120x190 / 120x200 cm.
matrimoniale 160x190 / 160x200 cm.
matrimoniale xl 180x190 / 180x200 cm.
queen 153x203 cm.

three-quarter size 120x190 / 120x200 cm.
double bed 160x190 / 160x200 cm.
double bed xl 180x190 / 180x200 cm.
queen 153x203 cm.

H. 28 GIROLETTO / GIROLETTO SAGOMATO

BED FRAME / SHAPED BED FRAME

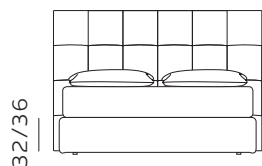

145

materasso largh. cm. 120
mattress width cm. 120

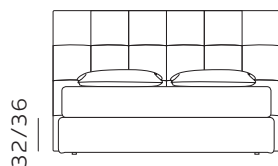

185

materasso largh. cm. 160
mattress width cm. 160

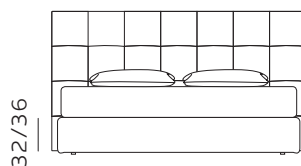

205

materasso largh. cm. 180
mattress width cm. 180

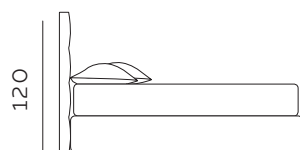

206

materasso lungh. cm. 190
mattress length cm. 190

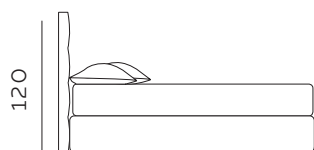

216

materasso lungh. cm. 200
mattress length cm. 200

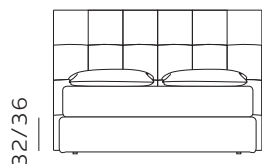

178

materasso largh. cm. 153
mattress width cm. 153

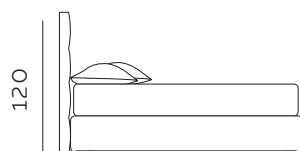

219

materasso lungh. cm. 203
mattress length cm. 203

H. 28 BOX CONTENITORE / BOX CONTENITORE EASY-UP STORAGE BOX / STORAGE BOX EASY-UP

Il box contenitore standard e box contenitore easy-up sono disponibili per giroletto standard e sagomato.
The standard storage box and easy-up storage box are available for both standard and shaped bed frames.

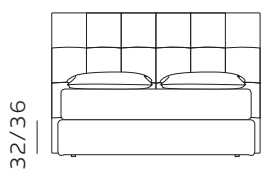

145

materasso largh. cm. 120
mattress width cm. 120

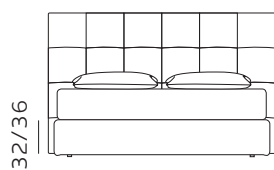

185

materasso largh. cm. 160
mattress width cm. 160

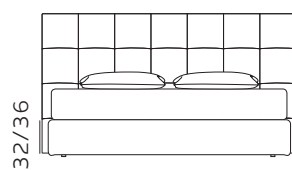

205

materasso largh. cm. 180
mattress width cm. 180

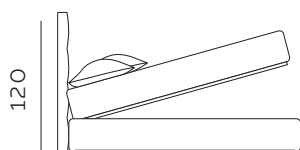

206

materasso lungh. cm. 190
mattress length cm. 190

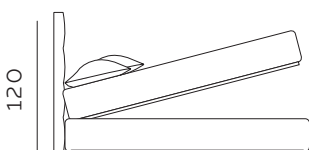

216

materasso lungh. cm. 200
mattress length cm. 200

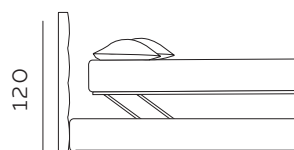

206

materasso lungh. cm. 190
mattress length cm. 190

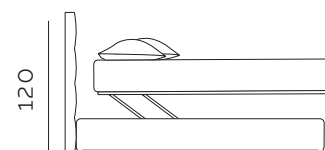

216

materasso lungh. cm. 200
mattress length cm. 200

88

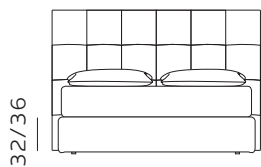

178

materasso largh. cm. 153
mattress width cm. 153

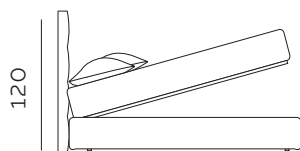

219

materasso lungh. cm. 203
mattress length cm. 203

Per le misure Queen e King non è prevista la versione box contenitore easy-up. / The easy-up box storage version is not available for Queen and King sizes.

RETE DI SERIE per BOX CONTENITORE – Standard o Easy Up - Struttura tubolare in acciaio verniciato a polveri e piano rete doppia campata con 14 listelle in multistrato di faggio misura 68x8 mm. (68x12 mm. nella versione 120) - supporto doghe singolo fisso in nylon anticigolio. Per eventuali richieste di sostituzione della rete di serie con modello alternativo richiedere fattibilità e preventivo all'ufficio vendite. / STANDAR BASE for STORAGE BOX– Standard or Easy Up - Tubular structure in powder-coated steel and a double-span slatted base with 14 beech plywood slats measuring 68x8 mm. (68x12 mm. for the 120 version) - fixed single slat supports in anti-squeak nylon. For any requests to replace the standard base with an alternative model, please request feasibility and quotation from the sales department.

H. 22 GIROLETTO BED FRAME

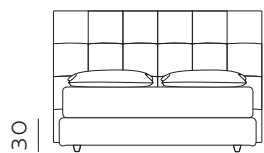

145

materasso largh. cm. 120
mattress width cm. 120

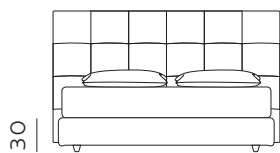

185

materasso largh. cm. 160
mattress width cm. 160

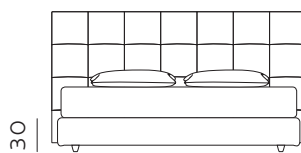

205

materasso largh. cm. 180
mattress width cm. 180

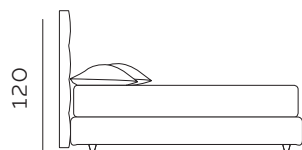

206

materasso lungh. cm. 190
mattress length cm. 190

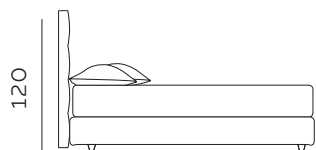

216

materasso lungh. cm. 200
mattress length cm. 200

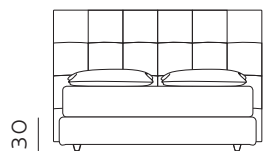

178

materasso largh. cm. 153
mattress width cm. 153

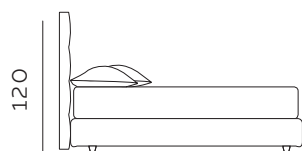

219

materasso lungh. cm. 203
mattress length cm. 203

H. 22 BOX CONTENITORE STORAGE BOX

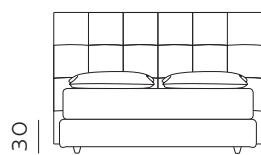

145

materasso largh. cm. 120
mattress width cm. 120

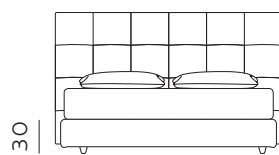

185

materasso largh. cm. 160
mattress width cm. 160

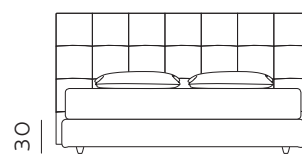

205

materasso largh. cm. 180
mattress width cm. 180

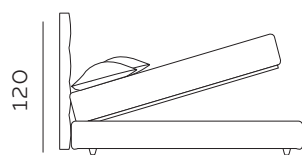

206

materasso lungh. cm. 190
mattress length cm. 190

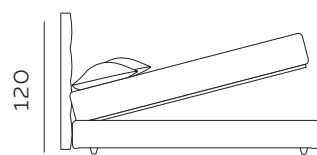

216

materasso lungh. cm. 200
mattress length cm. 200

90

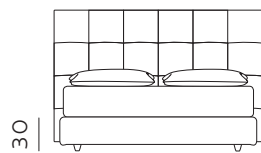

178

materasso largh. cm. 153
mattress width cm. 153

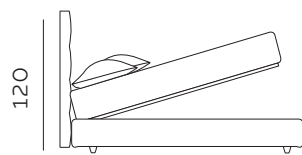

219

materasso lungh. cm. 203
mattress length cm. 203

RETE DI SERIE per BOX CONTENITORE – Standard o Easy Up – Struttura tubolare in acciaio verniciato a polveri e piano rete doppia campata con 14 listelle in multistrato di faggio misura 68x8 mm. (68x12 mm. nella versione 120) - supporto doghe singolo fisso in nylon anticigolio. Per eventuali richieste di sostituzione della rete di serie con modello alternativo richiedere fattibilità e preventivo all'ufficio vendite. / STANDAR BASE for STORAGE BOX– Standard or Easy Up - Tubular structure in powder-coated steel and a double-span slatted base with 14 beech plywood slats measuring 68x8 mm. (68x12 mm. for the 120 version) - fixed single slat supports in anti-squeak nylon. For any requests to replace the standard base with an alternative model, please request feasibility and quotation from the sales department.

PIEDINI PER GIROLETTO h. 22 e 28
FEET FOR BED FRAME h. 22 and 28

Sagomato h. 8 / Shaped h. 8



naturale
natural



wengé
wenge



nero laccato
lacquered black

**PIEDINO DI SERIE
PER GIROLETTO h. 22**
*STANDARD FEET
FOR BED FRAME h. 22*

Conico h. 8 / Conical h. 8



nero laccato
lacquered black

**PIEDINO DI SERIE
PER GIROLETTO h. 28**
*STANDARD FEET
FOR BED FRAME h. 28*

Cilindro h. 4 / Cylinder h. 4



nero laccato
lacquered black

Conico h. 8 / Conical h. 8



naturale
natural



rovere sbiancato
bleached oak



wengé
wenge



noce canaletto
canaletto walnut

Piramide h. 8 / Pyramid h. 8



naturale
natural



rovere sbiancato
bleached oak



wengé
wenge



nero laccato
lacquered black

Trapezio h. 8 / Trapezium h. 8



naturale
natural



nero laccato
lacquered black

Permette il passaggio del robot aspirapolvere
It allows passage for the robot vacuum cleaner



In fase di ordine deve essere specificata la
finitura del piedino laddove richiesto. / *Please*
specify foot finish when ordering if required.

Istruzioni di montaggio, vedi pag. 120
Assembly instructions, see page 120

Cartella tessuti, vedi pag 130
Fabric samples, see page 130

Listino prezzi, vedi pag 52
Price List, see page 52

ATLAS

Scheda tecnica / Technical data

Il letto Atlas è un letto imbottito sfoderabile disponibile in tutte le dimensioni e realizzabile in tutte e tre le altezze di giroletto: 28 cm. con box standard o versione easy-up con piedini di altezza 8 cm. e di serie di 4 cm., 22 cm. anche box contenitore e piedini di altezza 8 cm., 15 cm. con piedino conico o angolare di altezza 13 cm.

The Atlas bed is an upholstered, removable cover bed available in all sizes and it can be made in three bed frame heights: 28 cm. with standard box or easy-up box system with 8 cm. feet or standard feet of 4 cm.; 22 cm., with storage box and 8 cm. feet, and 15 cm. with cone or angular 13 cm. feet.



igiene sicura sfoderabile
e lavabile / safe hygiene
removable and washable



Immagine in alto
testiera / giroletto: Miami 56
piedini: cilindro nero laccato h. 4 cm.
Immagine in basso
testiera / giroletto: Aragon 59
piedini: piramide naturale h. 8 cm.

92

Image above
headboard / bed frame: Miami 56
feet: black lacquered cylinder h. 4 cm.
Image below
headboard / bed frame: Aragon 59
feet: natural pyramid h. 8 cm.



DIMENSIONI DISPONIBILI / AVAILABLE SIZES

singolo 80x190 / 80x200 cm.
piazza e mezza 120x190 / 120x200 cm.
matrimoniale 160x190 / 160x200 cm.
matrimoniale xl 180x190 / 180x200 cm.
queen 153x203 cm.
king 193x203 cm.
matrimoniale xxl 200x200 cm.

single 80x190 / 80x200 cm.
three-quarter size 120x190 / 120x200 cm.
double bed size 160x190 / 160x200 cm.
double bed xl 180x190 / 180x200 cm.
queen 153x203 cm.
king 193x203 cm.
double bed xxl 200x200 cm.

H. 28 GIROLETTO BED FRAME

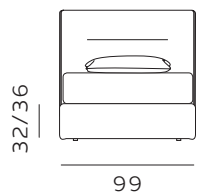

materasso largh. cm. 80
mattress width cm. 80

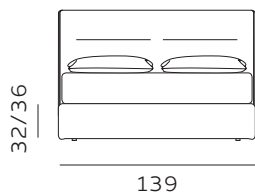

materasso largh. cm. 120
mattress width cm. 120

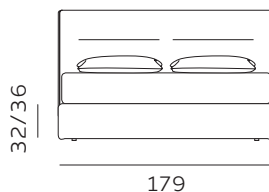

materasso largh. cm. 160
mattress width cm. 160

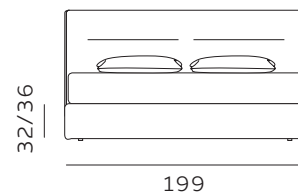

materasso largh. cm. 180
mattress width cm. 180

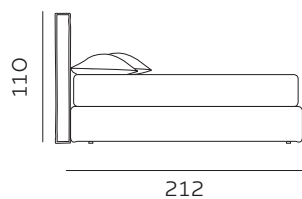

materasso lungh. cm. 190
mattress length cm. 190

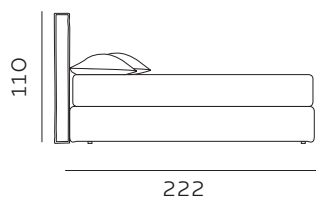

materasso lungh. cm. 200
mattress length cm. 200

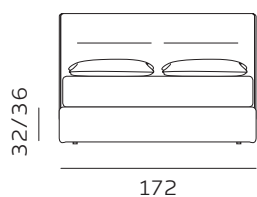

materasso largh. cm. 153
mattress width cm. 153

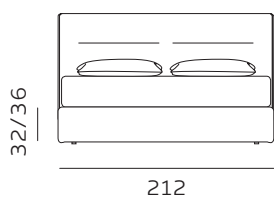

materasso largh. cm. 193
mattress width cm. 193

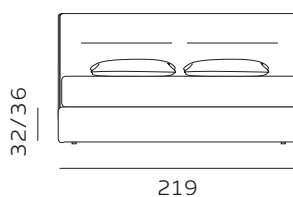

materasso largh. cm. 200
mattress width cm. 200

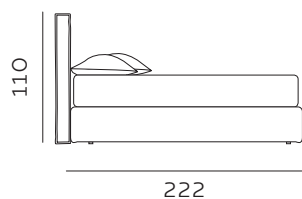

materasso lungh. cm. 200
mattress length cm. 200

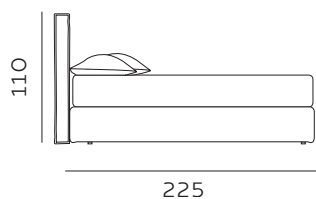

materasso lungh. cm. 203
mattress length cm. 203

H. 28 BOX CONTENITORE / BOX CONTENITORE EASY-UP STORAGE BOX / STORAGE BOX EASY-UP

Il box contenitore standard e box contenitore easy-up sono disponibili per giroletto standard e sagomato.
The standard storage box and easy-up storage box are available for both standard and shaped bed frames.

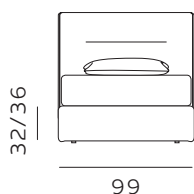

materasso largh. cm. 80
mattress width cm. 80

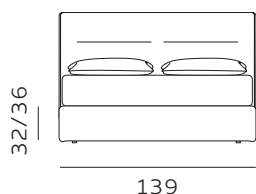

materasso largh. cm. 120
mattress width cm. 120

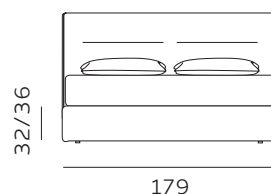

materasso largh. cm. 160
mattress width cm. 160

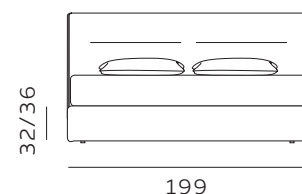

materasso largh. cm. 180
mattress width cm. 180

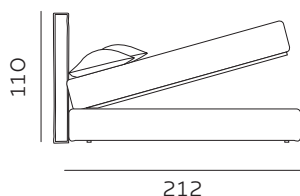

materasso lungh. cm. 190
mattress length cm. 190

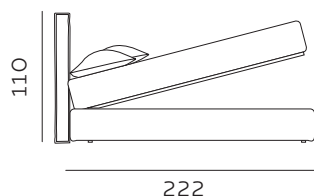

materasso lungh. cm. 200
mattress length cm. 200

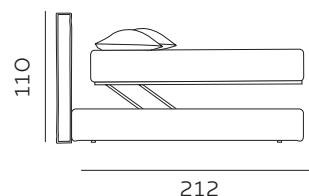

materasso lungh. cm. 190
mattress length cm. 190

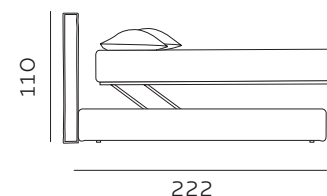

materasso lungh. cm. 200
mattress length cm. 200

94

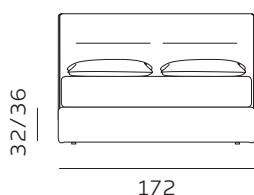

materasso largh. cm. 153
mattress width cm. 153

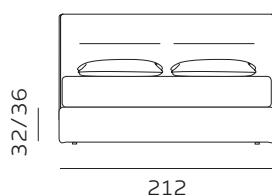

materasso largh. cm. 193
mattress width cm. 193

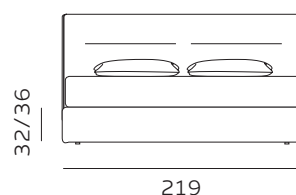

materasso largh. cm. 200
mattress width cm. 200

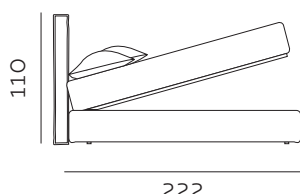

materasso lungh. cm. 200
mattress length cm. 200

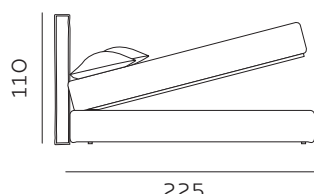

materasso lungh. cm. 203
mattress length cm. 203

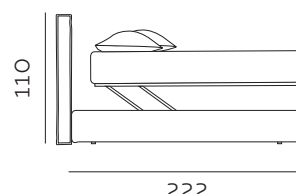

materasso lungh. cm. 200
mattress length cm. 200

Per le misure Queen e King non è prevista la versione box contenitore easy-up. / The easy-up box storage version is not available for Queen and King sizes.

RETE DI SERIE per BOX CONTENITORE – Standard o Easy Up - Struttura tubolare in acciaio verniciato a polveri e piano rete doppia campata con 14 listelle in multistrato di faggio misura 68x8 mm. (68x12 mm. nella versione 120) - supporto doghe singolo fisso in nylon anticigolio. Per eventuali richieste di sostituzione della rete di serie con modello alternativo richiedere fattibilità e preventivo all'ufficio vendite. / STANDAR BASE for STORAGE BOX– Standard or Easy Up - Tubular structure in powder-coated steel and a double-span slatted base with 14 beech plywood slats measuring 68x8 mm. (68x12 mm. for the 120 version) - fixed single slat supports in anti-squeak nylon. For any requests to replace the standard base with an alternative model, please request feasibility and quotation from the sales department.

H. 22 GIROLETTO BED FRAME

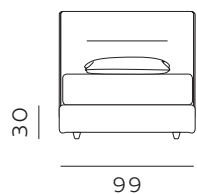

materasso largh. cm. 80
mattress width cm. 80

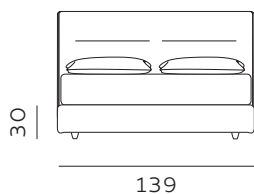

materasso largh. cm. 120
mattress width cm. 120

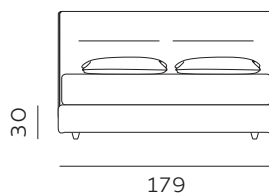

materasso largh. cm. 160
mattress width cm. 160

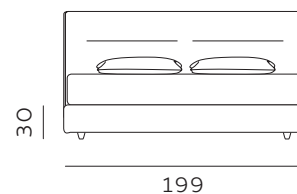

materasso largh. cm. 180
mattress width cm. 180

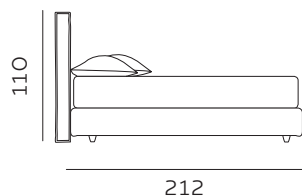

materasso lungh. cm. 190
mattress length cm. 190

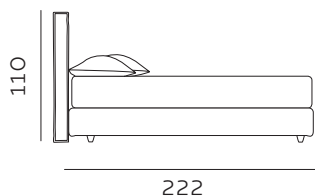

materasso lungh. cm. 200
mattress length cm. 200

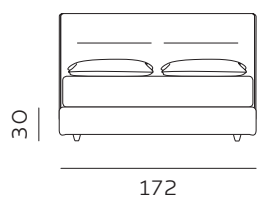

materasso largh. cm. 153
mattress width cm. 153

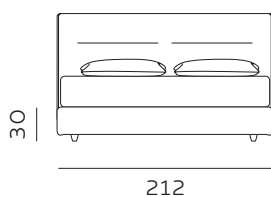

materasso largh. cm. 193
mattress width cm. 193

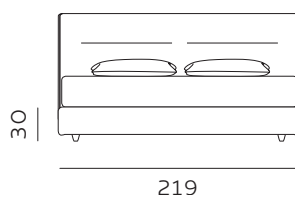

materasso largh. cm. 200
mattress width cm. 200

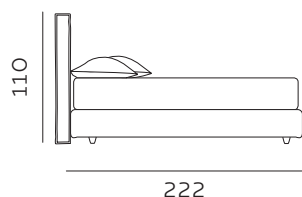

materasso lungh. cm. 200
mattress length cm. 200

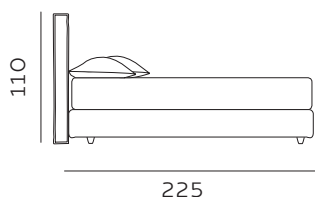

materasso lungh. cm. 203
mattress length cm. 203

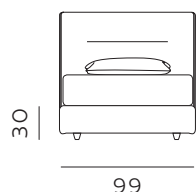

99
materasso largh. cm. 80
mattress width cm. 80

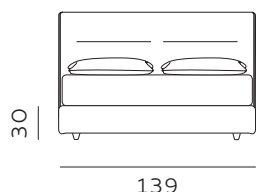

139
materasso largh. cm. 120
mattress width cm. 120

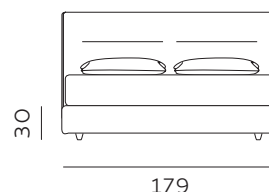

179
materasso largh. cm. 160
mattress width cm. 160

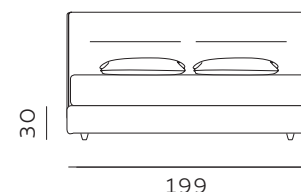

199
materasso largh. cm. 180
mattress width cm. 180

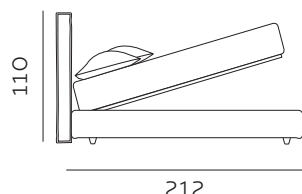

212
materasso lungh. cm. 190
mattress length cm. 190

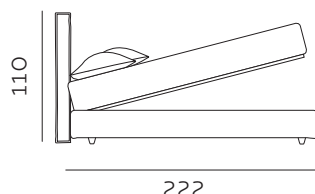

222
materasso lungh. cm. 200
mattress length cm. 200

96

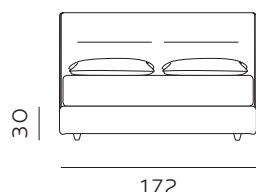

172
materasso largh. cm. 153
mattress width cm. 153

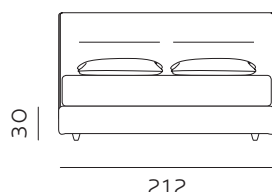

212
materasso largh. cm. 193
mattress width cm. 193

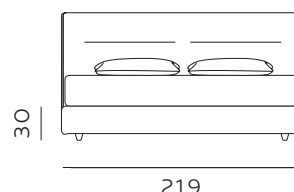

219
materasso largh. cm. 200
mattress width cm. 200

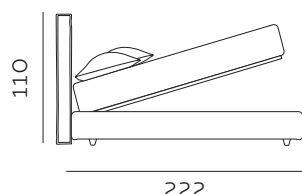

222
materasso lungh. cm. 200
mattress length cm. 200

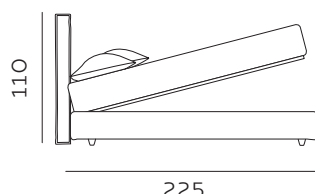

225
materasso lungh. cm. 203
mattress length cm. 203

RETE DI SERIE per BOX CONTENITORE – Standard o Easy Up – Struttura tubolare in acciaio verniciato a polveri e piano rete doppia campata con 14 listelle in multistrato di faggio misura 68x8 mm. (68x12 mm. nella versione 120) - supporto doghe singolo fisso in nylon anticigolio. Per eventuali richieste di sostituzione della rete di serie con modello alternativo richiedere fattibilità e preventivo all'ufficio vendite. / **STANDAR BASE for STORAGE BOX– Standard or Easy Up –** Tubular structure in powder-coated steel and a double-span slatted base with 14 beech plywood slats measuring 68x8 mm. (68x12 mm. for the 120 version) - fixed single slat supports in anti-squeak nylon. For any requests to replace the standard base with an alternative model, please request feasibility and quotation from the sales department.

PIEDINI PER GIROLETTO h. 22 e 28
FEET FOR BED FRAME h. 22 and 28

Sagomato h. 8 / Shaped h. 8



naturale
natural



wengé
wenge



nero laccato
lacquered black

**PIEDINO DI SERIE
PER GIROLETTO h. 22**
*STANDARD FEET
FOR BED FRAME h. 22*

Conico h. 8 / Conical h. 8



nero laccato
lacquered black

**PIEDINO DI SERIE
PER GIROLETTO h. 28**
*STANDARD FEET
FOR BED FRAME h. 28*

Cilindro h. 4 / Cylinder h. 4



nero laccato
lacquered black

Conico h. 8 / Conical h. 8



naturale
natural



rovere sbiancato
bleached oak



wengé
wenge



noce canaletto
canaletto walnut

Piramide h. 8 / Pyramid h. 8



naturale
natural



rovere sbiancato
bleached oak



wengé
wenge



nero laccato
lacquered black

Trapezio h. 8 / Trapezium h. 8



naturale
natural



nero laccato
lacquered black

Permette il passaggio del robot aspirapolvere
It allows passage for the robot vacuum cleaner



In fase di ordine deve essere specificata la
finitura del piedino laddove richiesto. / *Please*
specify foot finish when ordering if required.

Istruzioni di montaggio, vedi pag. 120
Assembly instructions, see page 120

Cartella tessuti, vedi pag 130
Fabric samples, see page 130

Listino prezzi, vedi pag 56
Price List, see page 56

H. 15

GIROLETTO
BED FRAME



99

materasso largh. cm. 80
mattress width cm. 80

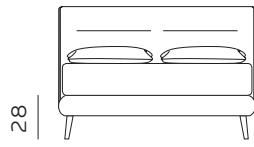

139

materasso largh. cm. 120
mattress width cm. 120

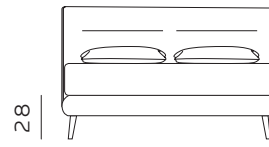

179

materasso largh. cm. 160
mattress width cm. 160

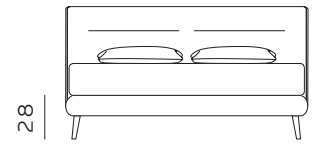

199

materasso largh. cm. 180
mattress width cm. 180

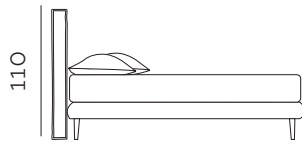

212

materasso lungh. cm. 190
mattress length cm. 190

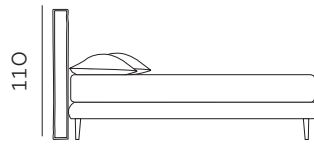

222

materasso lungh. cm. 200
mattress length cm. 200

98

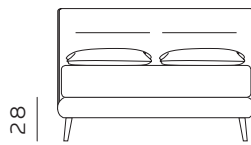

172

materasso largh. cm. 153
mattress width cm. 153

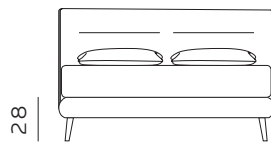

212

materasso largh. cm. 193
mattress width cm. 193

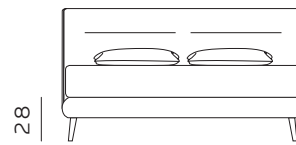

219

materasso largh. cm. 200
mattress width cm. 200

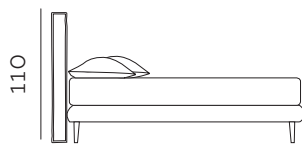

222

materasso lungh. cm. 200
mattress length cm. 200

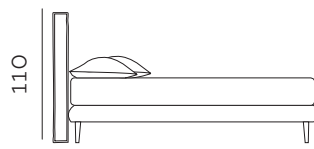

225

materasso lungh. cm. 203
mattress length cm. 203

PIEDINI / FEET

Conico h. 13 / Conical h. 13



naturale
natural



rovere sbiancato
bleached oak



wengé
wenge



noce canaletto
canaletto walnut

PIEDINO DI SERIE
PER GIROLETTO h. 15
STANDARD FEET
FOR BED FRAME h. 15
Conico h. 13 / Conical h. 13



nero laccato
lacquered black

Metallo angolare h. 13 / Angular metal h. 13



metallo nero
black metal

Permette il passaggio del robot aspirapolvere
It allows passage for the robot vacuum cleaner



In fase di ordine deve essere specificata la
finitura del piedino laddove richiesto. / Please
specify foot finish when ordering if required.

Istruzioni di montaggio, vedi pag. 122
Assembly instructions, see page 122

Cartella tessuti, vedi pag 130
Fabric samples, see page 130

Listino prezzi, vedi pag 56
Price List, see page 56

BASIC SOMMIER

Scheda tecnica / Technical data

Basic sommier è disponibile in tutte le misure. È sfoderabile e realizzabile in tutte e tre le altezze di giroletto: 28 cm. anche con box standard o versione easy-up con piedini di altezza 8 cm. e di serie di 4 cm., 22 cm. anche con box contenitore e piedini di altezza 8 cm., 15 cm. con piedino conico o angolare di altezza 13 cm.

The Basic sommier is available in all sizes. It is a removable bed base and can be manufactured in three bed frame heights: 28 cm. available with standard box or easy-up box system with 8 cm. feet or standard feet of 4 cm.; 22 cm., with storage box and 8 cm. feet, and 15 cm. with cone or angular 13 cm. feet.



Immagine in alto
giroletto: Alghero 115
piedini: cilindro nero laccato h. 4 cm.
Immagine in basso
giroletto: Spice O2
piedini: piramide nero laccato h. 8 cm.

100

Image above
bed frame: Alghero 115
feet: black lacquered cylinder h. 4 cm.
Image below
bed frame: Spice O2
feet: black lacquered pyramid h. 8 cm.



igiene sicura sfoderabile
e lavabile / safe hygiene
removable and washable



DIMENSIONI DISPONIBILI / AVAILABLE SIZES

singolo 80x190 / 80x200 cm.
piazza e mezza 120x190 / 120x200 cm.
matrimoniale 160x190 / 160x200 cm.
matrimoniale xl 180x190 / 180x200 cm.
queen 153x203 cm.
king 193x203 cm.
matrimoniale xxl 200x200 cm.

single 80x190 / 80x200 cm.
three-quarter size 120x190 / 120x200 cm.
double bed size 160x190 / 160x200 cm.
double bed xl 180x190 / 180x200 cm.
queen 153x203 cm.
king 193x203 cm.
double bed xxl 200x200 cm.

H. 28 GIROLETTO BED FRAME

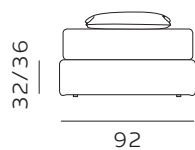

materasso largh. cm. 80
mattress width cm. 80

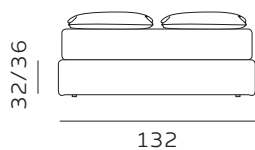

materasso largh. cm. 120
mattress width cm. 120

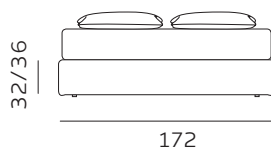

materasso largh. cm. 160
mattress width cm. 160

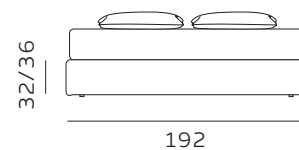

materasso largh. cm. 180
mattress width cm. 180

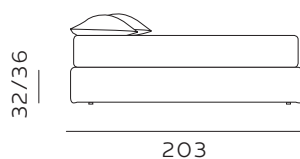

materasso lungh. cm. 190
mattress length cm. 190

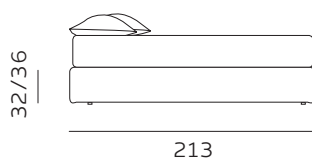

materasso lungh. cm. 200
mattress length cm. 200

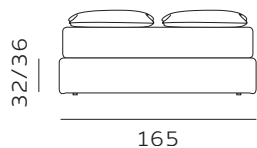

materasso largh. cm. 153
mattress width cm. 153

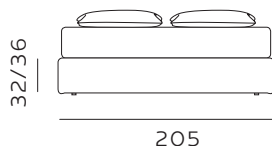

materasso largh. cm. 193
mattress width cm. 193

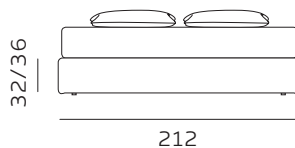

materasso largh. cm. 200
mattress width cm. 200

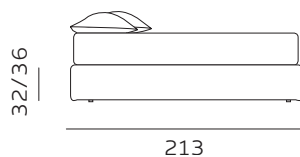

materasso lungh. cm. 200
mattress length cm. 200

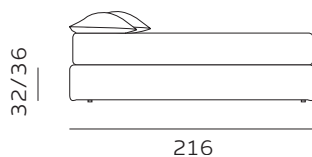

materasso lungh. cm. 203
mattress length cm. 203

H. 28 BOX CONTENITORE / BOX CONTENITORE EASY-UP

STORAGE BOX / STORAGE BOX EASY-UP

Il box contenitore standard e box contenitore easy-up sono disponibili per giroletto standard e sagomato.
 The standard storage box and easy-up storage box are available for both standard and shaped bed frames.

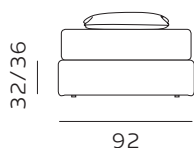

materasso largh. cm. 80
 mattress width cm. 80

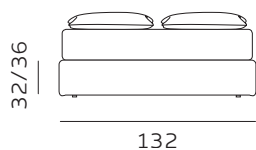

materasso largh. cm. 120
 mattress width cm. 120

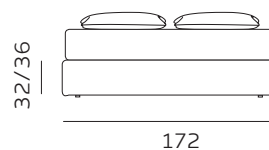

materasso largh. cm. 160
 mattress width cm. 160

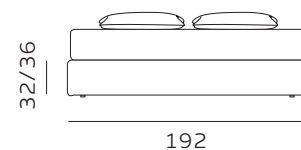

materasso largh. cm. 180
 mattress width cm. 180

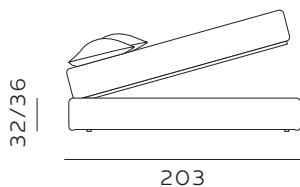

materasso lungh. cm. 190
 mattress length cm. 190

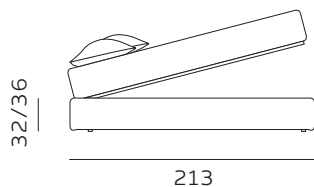

materasso lungh. cm. 200
 mattress length cm. 200

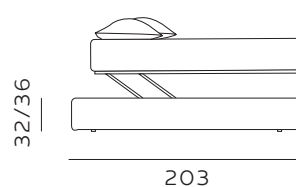

materasso lungh. cm. 190
 mattress length cm. 190

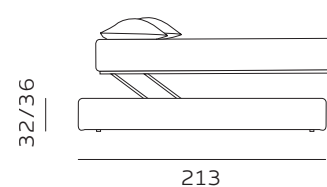

materasso lungh. cm. 200
 mattress length cm. 200

102

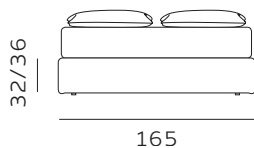

materasso largh. cm. 153
 mattress width cm. 153

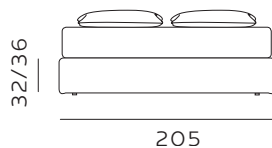

materasso largh. cm. 193
 mattress width cm. 193

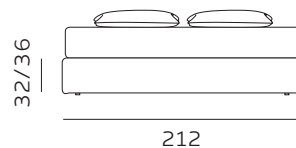

materasso largh. cm. 200
 mattress width cm. 200

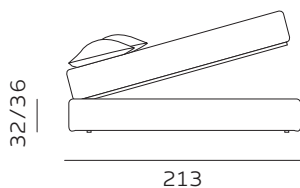

materasso lungh. cm. 200
 mattress length cm. 200

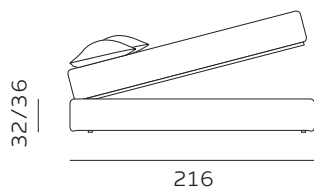

materasso lungh. cm. 203
 mattress length cm. 203

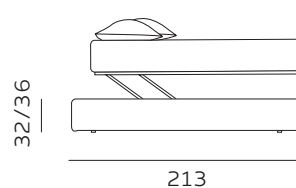

materasso lungh. cm. 200
 mattress length cm. 200

Per le misure Queen e King non è prevista la versione box contenitore easy-up. / The easy-up box storage version is not available for Queen and King sizes.

RETE DI SERIE per BOX CONTENITORE – Standard o Easy Up - Struttura tubolare in acciaio verniciato a polveri e piano rete doppia campata con 14 listelle in multistrato di faggio misura 68x8 mm. (68x12 mm. nella versione 120) - supporto doghe singolo fisso in nylon anticigolio. Per eventuali richieste di sostituzione della rete di serie con modello alternativo richiedere fattibilità e preventivo all'ufficio vendite. / STANDAR BASE for STORAGE BOX– Standard or Easy Up - Tubular structure in powder-coated steel and a double-span slatted base with 14 beech plywood slats measuring 68x8 mm. (68x12 mm. for the 120 version) - fixed single slat supports in anti-squeak nylon. For any requests to replace the standard base with an alternative model, please request feasibility and quotation from the sales department.

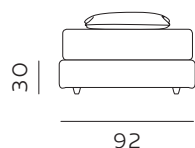

materasso largh. cm. 80
mattress width cm. 80

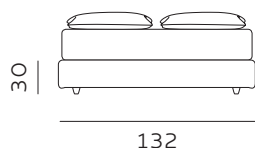

materasso largh. cm. 120
mattress width cm. 120

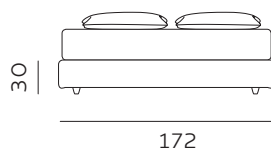

materasso largh. cm. 160
mattress width cm. 160

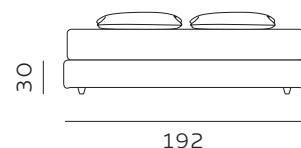

materasso largh. cm. 180
mattress width cm. 180

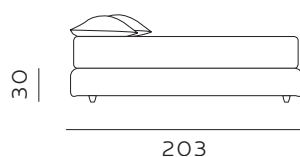

materasso lungh. cm. 190
mattress length cm. 190

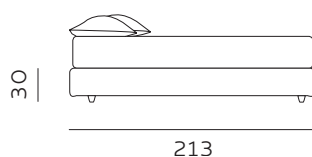

materasso lungh. cm. 200
mattress length cm. 200

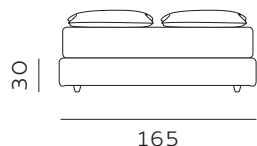

materasso largh. cm. 153
mattress width cm. 153

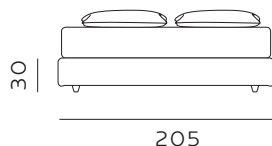

materasso largh. cm. 193
mattress width cm. 193

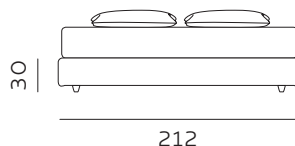

materasso largh. cm. 200
mattress width cm. 200

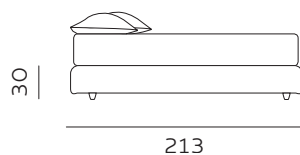

materasso lungh. cm. 200
mattress length cm. 200

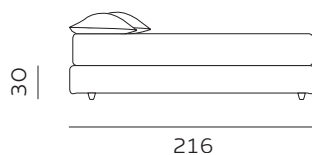

materasso lungh. cm. 203
mattress length cm. 203

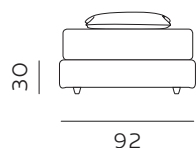

92
materasso largh. cm. 80
mattress width cm. 80

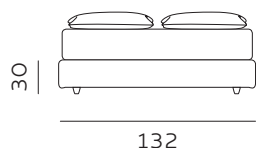

132
materasso largh. cm. 120
mattress width cm. 120

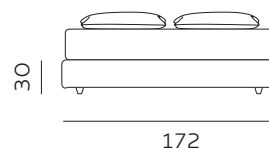

172
materasso largh. cm. 160
mattress width cm. 160

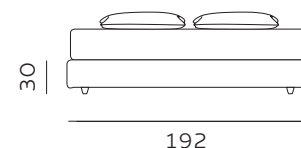

192
materasso largh. cm. 180
mattress width cm. 180

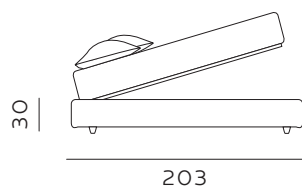

203
materasso lungh. cm. 190
mattress length cm. 190

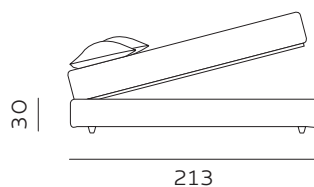

213
materasso lungh. cm. 200
mattress length cm. 200

104

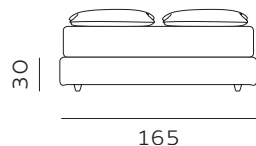

165
materasso largh. cm. 153
mattress width cm. 153

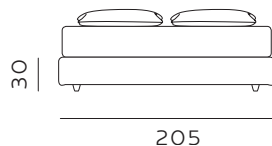

205
materasso largh. cm. 193
mattress width cm. 193

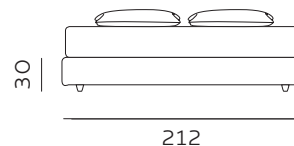

212
materasso largh. cm. 200
mattress width cm. 200

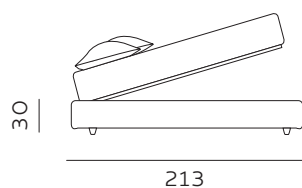

213
materasso lungh. cm. 200
mattress length cm. 200

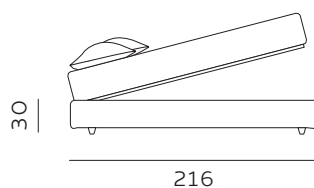

216
materasso lungh. cm. 203
mattress length cm. 203

RETE DI SERIE per BOX CONTENITORE – Standard o Easy Up – Struttura tubolare in acciaio verniciato a polveri e piano rete doppia campata con 14 listelle in multistrato di faggio misura 68x8 mm. (68x12 mm. nella versione 120) - supporto doghe singolo fisso in nylon anticigolio. Per eventuali richieste di sostituzione della rete di serie con modello alternativo richiedere fattibilità e preventivo all'ufficio vendite. / **STANDAR BASE for STORAGE BOX– Standard or Easy Up –** Tubular structure in powder-coated steel and a double-span slatted base with 14 beech plywood slats measuring 68x8 mm. (68x12 mm. for the 120 version) - fixed single slat supports in anti-squeak nylon. For any requests to replace the standard base with an alternative model, please request feasibility and quotation from the sales department.

PIEDINI PER GIROLETTO h. 22 e 28
FEET FOR BED FRAME h. 22 and 28

Sagomato h. 8 / Shaped h. 8



naturale
natural



wengé
wenge



nero laccato
lacquered black

PIEDINO DI SERIE
PER GIROLETTO h. 22
STANDARD FEET
FOR BED FRAME h. 22

Conico h. 8 / Conical h. 8



nero laccato
lacquered black

PIEDINO DI SERIE
PER GIROLETTO h. 28
STANDARD FEET
FOR BED FRAME h. 28

Cilindro h. 4 / Cylinder h. 4



nero laccato
lacquered black

Conico h. 8 / Conical h. 8



naturale
natural



rovere sbiancato
bleached oak



wengé
wenge



noce canaletto
canaletto walnut

Piramide h. 8 / Pyramid h. 8



naturale
natural



rovere sbiancato
bleached oak



wengé
wenge



nero laccato
lacquered black

Trapezio h. 8 / Trapezium h. 8



naturale
natural



nero laccato
lacquered black

Permette il passaggio del robot aspirapolvere
It allows passage for the robot vacuum cleaner



In fase di ordine deve essere specificata la
finitura del piedino laddove richiesto. / Please
specify foot finish when ordering if required.

Istruzioni di montaggio, vedi pag. 120
Assembly instructions, see page 120

Cartella tessuti, vedi pag 130
Fabric samples, see page 130

Listino prezzi, vedi pag 60
Price List, see page 60

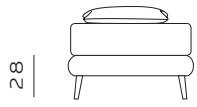

92

materasso largh. cm. 80
mattress width cm. 80

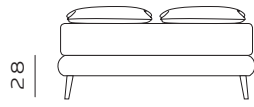

132

materasso largh. cm. 120
mattress width cm. 120

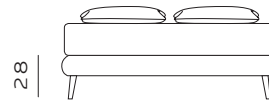

172

materasso largh. cm. 160
mattress width cm. 160

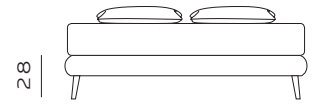

192

materasso largh. cm. 180
mattress width cm. 180

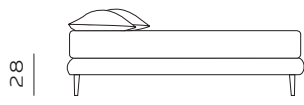

203

materasso lungh. cm. 190
mattress length cm. 190

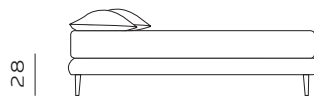

213

materasso lungh. cm. 200
mattress length cm. 200

106

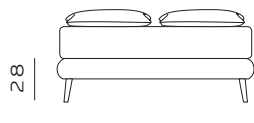

165

materasso largh. cm. 153
mattress width cm. 153

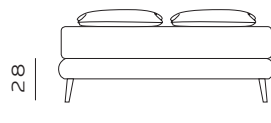

205

materasso largh. cm. 193
mattress width cm. 193

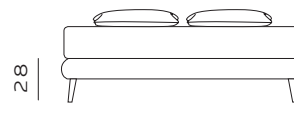

212

materasso largh. cm. 200
mattress width cm. 200

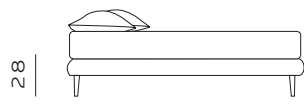

213

materasso lungh. cm. 200
mattress length cm. 200

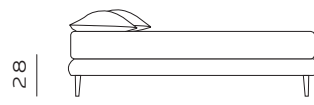

216

materasso lungh. cm. 203
mattress length cm. 203

PIEDINI / FEET

Conico h. 13 / Conical h. 13



naturale
natural



rovere sbiancato
bleached oak



wengé
wenge



noce canaletto
canaletto walnut

PIEDINO DI SERIE
PER GIROLETTO h. 15
STANDARD FEET
FOR BED FRAME h. 15

Conico h. 13 / Conical h. 13



nero laccato
lacquered black

Metallo angolare h. 13 / Angular metal h. 13



metallo nero
black metal

Permette il passaggio del robot aspirapolvere
It allows passage for the robot vacuum cleaner



In fase di ordine deve essere specificata la
finitura del piedino laddove richiesto. / Please
specify foot finish when ordering if required.

Istruzioni di montaggio, vedi pag. 122
Assembly instructions, see page 122

Cartella tessuti, vedi pag 130
Fabric samples, see page 130

Listino prezzi, vedi pag 60
Price List, see page 60

107

SIRIO*

Scheda tecnica / Technical data

Sirio è un pratico letto salva spazio, personalizzabile in 12 configurazioni possibili, con giroletto di altezza 30 cm., in versione standard, easy-up, automatica e manuale, e due diverse tipologie di piedini: piedino di serie e ruota piroettante entrambi di altezza 4 cm.

Sirio is a practical space-saving bed, customizable in 12 possible configurations, with a bed frame height of 30 cm. It is available in standard, easy-up, automatic, and manual versions, and with two different types of feet: standard feet and swivel castors, both with a height of 4 cm.



Immagine in alto
testiera / giroletto: Canvas Sand
piedini: cilindro nero laccato h. 4 cm.
Immagine in basso
testiera / giroletto: Miami 48
piedini: cilindro nero laccato h. 4 cm.

108

Image above
headboard / bed frame: Canvas Sand
feet: black lacquered cylinder h. 4 cm.
Image below
headboard / bed frame: Miami 48
feet: black lacquered cylinder h. 4 cm.



igiene sicura sfoderabile
e lavabile / safe hygiene
removable and washable



DIMENSIONI DISPONIBILI / AVAILABLE SIZES

singolo 80x190 cm.
singolo 90x200 cm.
piazza e mezza 120x200 cm.

*single 80x190 cm.
single 90x200 cm.
three-quarter size 120x200 cm.*

H. 30 GIROLETTO / GIROLETTO ESTRAIBILE APERTURA AUTOMATICA O MANUALE
 BED FRAME / PULL-OUT BED FRAME WITH AUTOMATIC OR MANUAL OPENING

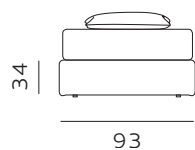

materasso largh. cm. 80
 mattress width cm. 80

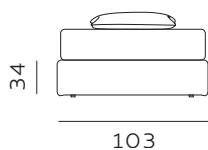

materasso largh. cm. 90
 mattress width cm. 90

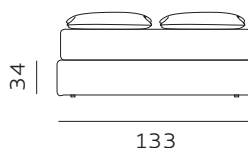

materasso largh. cm. 120
 mattress width cm. 120

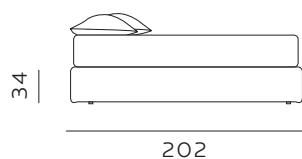

materasso lungh. cm. 190
 mattress length cm. 190

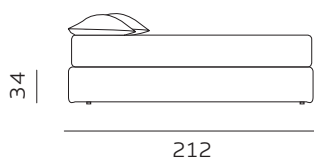

materasso lungh. cm. 200
 mattress length cm. 200

NOTE: rete per piano letto compresa nel prezzo
 NOTES: the bed base is included in the price.

109

H. 30 STANDARD CONTENITORE / CONTENITORE EASY-UP
 STANDARD STORAGE BOX / STORAGE BOX EASY-UP

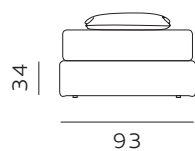

materasso largh. cm. 80
 mattress width cm. 80

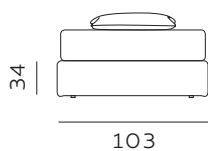

materasso largh. cm. 90
 mattress width cm. 90

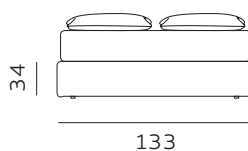

materasso largh. cm. 120
 mattress width cm. 120

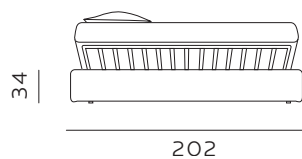

materasso lungh. cm. 190
 mattress length cm. 190

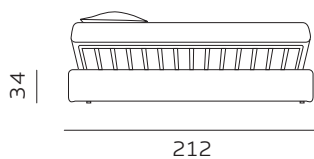

materasso lungh. cm. 200
 mattress length cm. 200

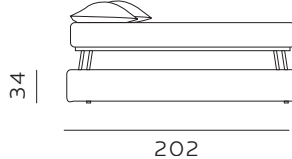

materasso lungh. cm. 190
 mattress length cm. 190

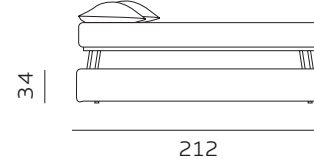

materasso lungh. cm. 200
 mattress length cm. 200

SECONDO LETTO APERTURA AUTOMATICA / APERTURA MANUALE
 SECOND BED AUTOMATIC OPENING / MANUAL OPENING

APERTURA AUTOMATICA / AUTOMATIC OPENING

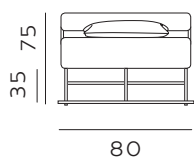

materasso largh. cm. 75
 mattress width cm. 75

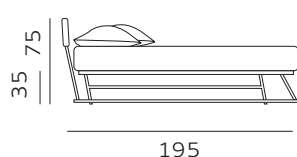

materasso lungh. cm. 185
 mattress length cm. 185

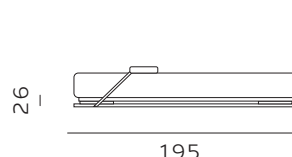

materasso lungh. cm. 185
 mattress length cm. 185

APERTURA MANUALE / MANUAL OPENING

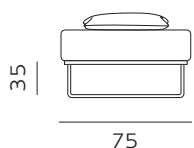

materasso largh. cm. 75
 mattress width cm. 75

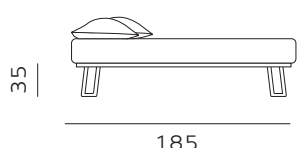

materasso lungh. cm. 185
 mattress length cm. 185

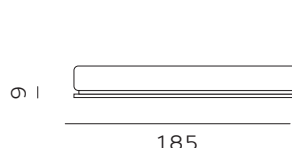

materasso lungh. cm. 185
 mattress length cm. 185

110

NOTE: per dimensione cm. 120 x 200
 si consideri dimensione rete singola per letto
 estraibile / NOTES: for size cm. 120 x 200
 consider single bed base size for pull-out bed

Misura del materasso estraibile /
 Pull-out mattress size

Mod. FAST DI ENNEREV
 L75 x P185 x H15 cm.
 in alternativa
 Mod. JONNI
 L75 x P185 x H13 cm.
 Mod. BAJA
 L75 x P185 x H15 cm.

Mod. ENNEREV FAST
 W75 x D185 x H15 cm.
 or
 Mod. JONNI
 L75 x P185 x H13 cm.
 Mod. BAJA
 L75 x P185 x H15 cm.

PIEDINO DI SERIE
 STANDARD FEET

Cilindro h. 4 / Cylinder h. 4



nero laccato
 lacquered black

Ruota piroettante h. 4 / Swivel caster h. 4



nero
 black

Non disponibile per la
 versione estraibile / not
 available for the pull-out
 bed frame version

In fase di ordine deve essere specificata la
 finitura del piedino laddove richiesto. / Please
 specify foot finish when ordering if required.

Istruzioni di montaggio, vedi pag. 125
 Assembly instructions, see page 125

Cartella tessuti, vedi pag. 130
 Fabric samples, see page 130

Listino prezzi, vedi pag. 64
 Price List, see page 64

SCHEDA TECNICA / TECHNICAL DATA



Sommier / Box spring

(80x190) L202xP93xH34
(90x200) L212xP103xH34
(120x200) L212xP133xH34

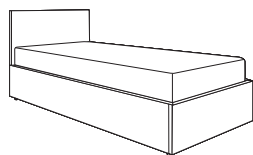

Letto / Bed

(80x190) L202xP93xH86
(90x200) L212xP103xH86
(120x200) L212xP133xH86

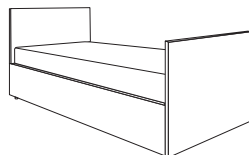

Dormeuse

(80x190) L202xP93xH86/71
(90x200) L212xP103xH86/71
(120x200) L212xP133xH86/71



Angolo basso sx /
Low lh corner

(80x190) L202xP93xH71
(90x200) L212xP103xH71
(120x200) L212xP133xH71

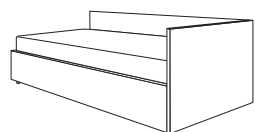

Angolo basso dx /
Low rh corner

(80x190) L202xP93xH71
(90x200) L212xP103xH71
(120x200) L212xP133xH71

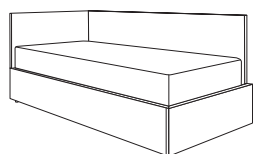

Angolo alto sx /
High lh corner

(80x190) L202xP93xH86
(90x200) L212xP103xH86
(120x200) L212xP133xH86

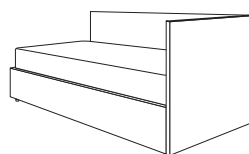

Angolo alto dx / high rh corner

(80x190) L202xP93xH86
(90x200) L212xP103xH86
(120x200) L212xP133xH86

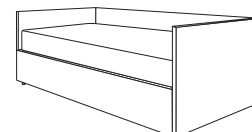

Divano basso / Low sofa

(80x190) L202xP93xH71
(90x200) L212xP103xH71
(120x200) L212xP133xH71

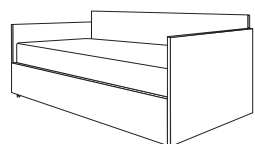

Divano alto / High sofa

(80x190) L202xP93xH86/71
(90x200) L212xP103xH86/71
(120x200) L212xP133xH86/71

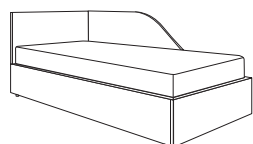

Angolo sagomato sx /
Shaped lh corner

(80x190) L202xP93xH86
(90x200) L212xP103xH86
(120x200) L212xP133xH86

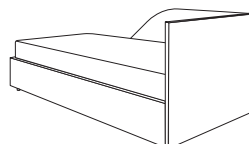

Angolo sagomato dx /
Shaped rh corner

(80x190) L202xP93xH86
(90x200) L212xP103xH86
(120x200) L212xP133xH86

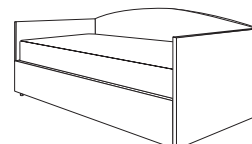

Sofà

(80x190) L202xP93xH78/71
(90x200) L212xP103xH78/71
(120x200) L212xP133xH78/71

NAOS

Scheda tecnica / Technical data

All'apparenza un pouf dalle dimensioni generose, ma con un semplice gesto Naos si trasforma in un pratico e comodo letto.

Apparently a generously sized pouf, but with a simple gesture Naos transforms into a practical and comfortable bed.



igiene sicura sfoderabile
e lavabile / safe hygiene
removable and washable



112

Immagine in basso
Tessuto rivestimento: Miami 48

Image above
Fabric upholstery: Miami 48



MISURE / SIZES

chiuso L76 x P75 x H45 cm.
aperto L76 x P210 x H45 cm.

*closed W76 x D75 x H45 cm.
open W76 x D210 x H45 cm.*



113

Misura del materasso / *mattress size*
L75 x P197 x H10cm.
W75 x D197 x H10cm.

Materasso compreso nel prezzo dell'articolo
The mattress is included in the price.

Cartella tessuti, vedi pag 130
Fabric samples, see page 130

Listino prezzi, vedi pag 71
Price List, see page 71

POUF

I pouf sono complementi d'arredo versatili e funzionali, ideali per aggiungere comfort e stile a qualsiasi ambiente. Di diverse forme e misure, possono essere usati come poggiatesta, sedute extra o semplici elementi decorativi, adattandosi perfettamente a ogni spazio. / *Poufs are versatile and functional pieces of furniture, ideal for adding comfort and style to any environment. Available in various shapes and sizes, they can be used as footrests, extra seats, or simple decorative elements, perfectly fitting any space.*





JOY

Imbottitura morbida di perle di polistirolo/
soft padding in polystyrene pearls

DIMENSIONE / SIZE

diam. 60 - H. 45 cm.
diameter 60 - H. 45 cm.



116

CUBO SOFT

imbottitura in poliuretano/
polyurethane padding

DIMENSIONE / SIZE

L45 x P45 x H45 cm.
W45 x D45 x H45 cm.



CILINDRO SOFT

imbottitura in poliuretano/
polyurethane padding

DIMENSIONE / SIZE

diam. 45 - H. 45 cm.
diameter 45 - H. 45 cm.



117

SACCO

imbottitura morbida in perle di polistirolo/
soft padding in polystyrene pearls

DIMENSIONE / SIZE

L60 x P60 x H45 cm.
W60 x D60 x H45 cm.



GRACE

struttura in legno e imbottitura in poliuretano/
wooden structure and polyurethane padding

DIMENSIONE / SIZE

L140 / 160 / 180 x P50 x H.48
W140 / 160 / 180 x D50 x H.48



MARJON

struttura in legno e imbottitura in poliuretano/
wooden structure and polyurethane padding

118

DIMENSIONE / SIZE

L135 x P50 x H38 cm.
W135 x D50 x H38 cm.



WILSON

struttura in legno e imbottitura in poliuretano/
wooden structure and polyurethane padding

DIMENSIONE / SIZE

L50 x P50 x H38 cm.
W50 x D50 x H38 cm.



PER LE PANCHETTE MARION / WILSON / GRACE
FOR MARION / WILSON / GRACE BENCH

Sagomato h. 8 / Shaped h. 8



naturale
natural



wengé
wenge



nero laccato
lacquered black

PIEDINO DI SERIE
STANDARD FEET

Conico h. 13 / Conical h. 13



nero laccato
lacquered black

Conico h. 8 / Conical h. 8



naturale
natural



rovere sbiancato
bleached oak



wengé
wenge



noce canaletto
canaletto walnut

Piramide h. 8 / Pyramid h. 8



naturale
natural



rovere sbiancato
bleached oak



wengé
wenge



nero laccato
lacquered black

Trapezio h. 8 / Trapezium h. 8



naturale
natural



nero laccato
lacquered black

Metallo angolare h. 13 / Angular metal h. 13



metallo nero
black metal

In fase di ordine deve essere specificata la
finitura del piedino laddove richiesto. / Please
specify foot finish when ordering if required.

Cartella tessuti, vedi pag 130
Fabric samples, see page 130

Listino prezzi, vedi pag 72
Price List, see page 72

ISTRUZIONI DI MONTAGGIO/ASSEMBLING INSTRUCTIONS

Schema di montaggio LETTO STRUTTURA H. 22 e 28 cm. / Assembly framework for BED FRAME HEIGHT 22 and 28 cm.



Per il montaggio necessitano 2 persone
Assembly requires 2 people

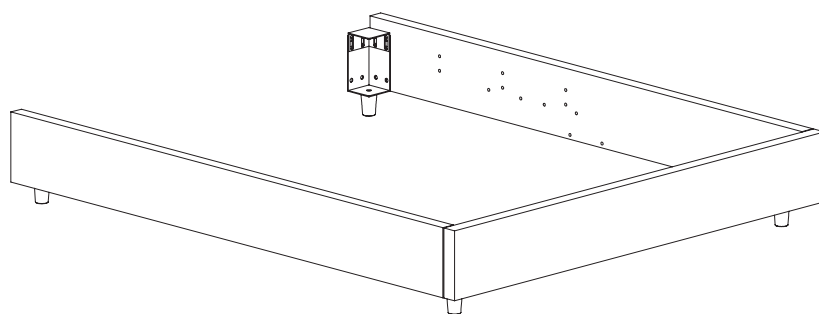

Posizione angolari
Corner position

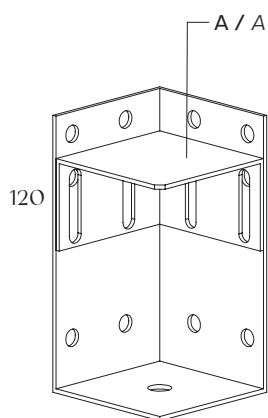

Giroletto e Box
Strutture h. 22 /
Bed frame and Box
Structures h. 22

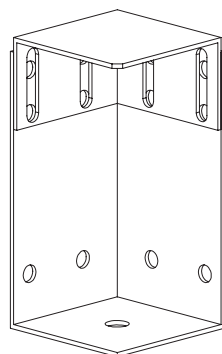

Giroletto e Box /
Bed frame and Box

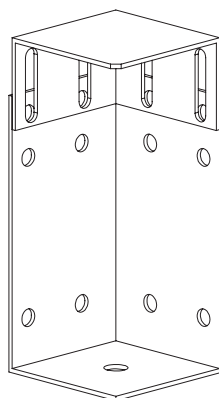

Giroletto e Box
Strutture h. 28 /
Bed frame and box
Structures h. 28

Assemblare la struttura del giroletto, facendo attenzione alla posizione degli angolari (A), abbiamo riportato le posizioni in riferimento ad una rete con ingombro totale 5 cm. / Assemble the bed frame, paying attention to the position of the corners (A), we have shown the positions with reference to a bed frame with overall dimensions total 5 cm.

ATTENZIONE per il fissaggio di ogni singolo angolare sono sufficienti solo **8 viti**, 4 nella parte inferiore e 4 in quella superiore che comunque fissano anche l'angolare appoggio rete / **ATTENTION** for the fastening of each individual corner only **8 screws** are required, 4 at the bottom and 4 at the top which also fix the corner frame support

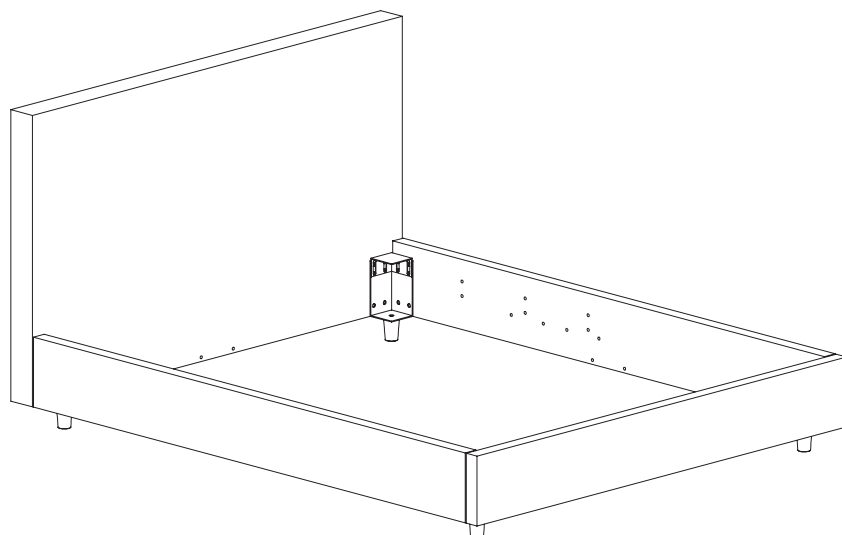

Montare i piedini e rivestire la stessa con il tessuto / Mount the feet and cover with the fabric

Assemblare quindi la testiera alla struttura
Then assemble the headboard to the structure

ISTRUZIONI DI MONTAGGIO/ASSEMBLING INSTRUCTIONS

Schema di montaggio BOX CONTENITORE STANDARD, EASY-UP / Assembly framework for STANDARD, EASY-UP STORAGE BOX



Per il montaggio necessitano 2 persone
Assembly requires 2 people

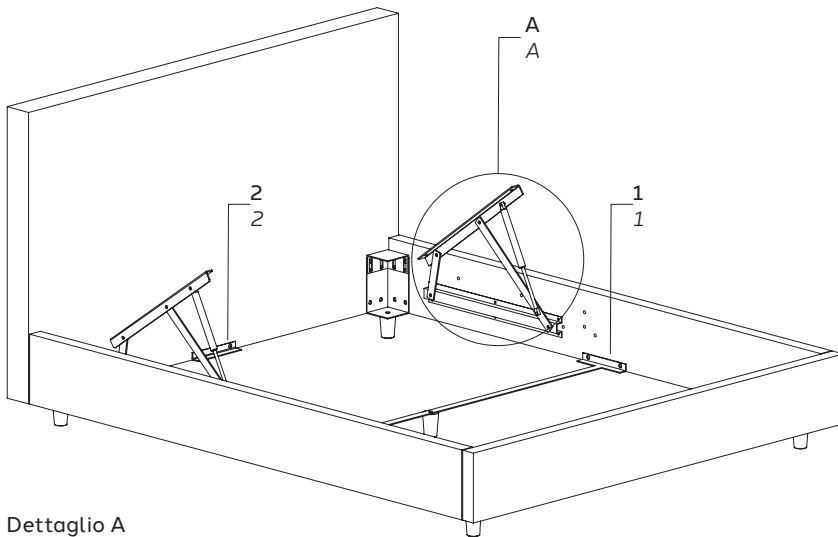

Fissare la barra supporto fondo (1) ai longoni e fissare il piede alla stessa. Fissare le staffe supporto fondo (2) alla testiera e alla pediera. Fissare i meccanismi ai longoni e fissare la molla a gas ai meccanismi. Attaccare la guarnizione parapolvere ai fondi come indicato a lato.
Fasten the bottom support bar (1) to the beams and fasten the foot to it. Fasten the bottom support brackets (2) to the headboard and to the footboard. Fasten the mechanisms to the beams and fasten the gas spring to the mechanisms. Attach the dust seal to the bottoms as indicated on the side.

Dettaglio A
Detail A

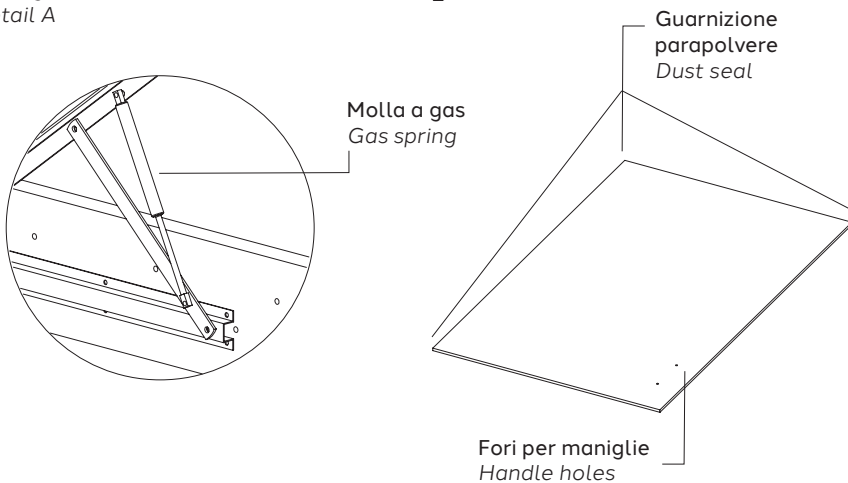

Inserire i fondi removibili. Fissare la rete ai meccanismi, facendo attenzione ad usare i fori A per aggancio ai meccanismi standard o i B per aggancio ai meccanismi easy-up. Vedi dettaglio.
Insert the removable bottoms. Attach the bed frame to the mechanisms, taking care to use holes A for the standard mechanisms or holes B for easy-up mechanisms. See detail.

121

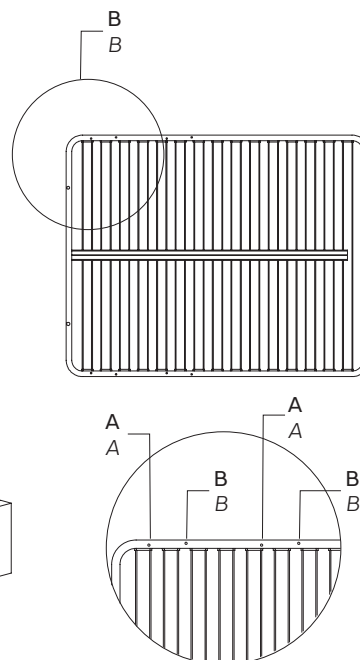
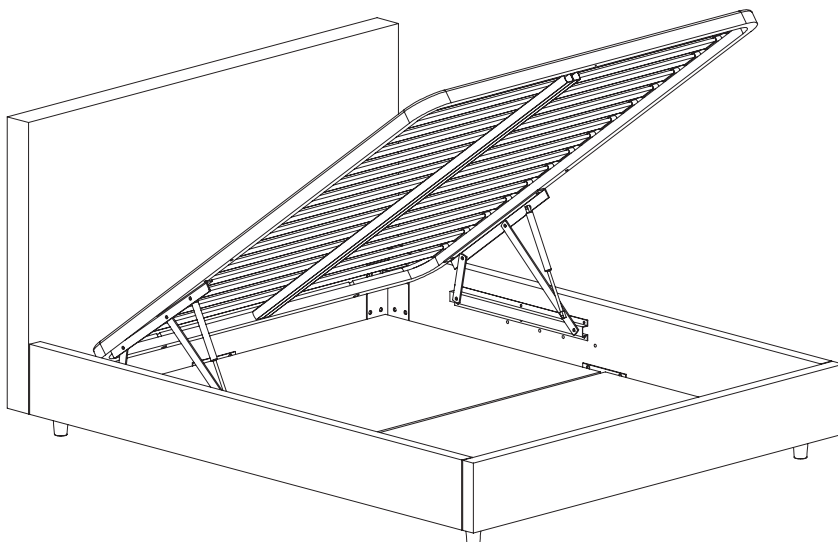

Dettaglio B
Detail B

ISTRUZIONI DI MONTAGGIO/ASSEMBLING INSTRUCTIONS

Schema di montaggio LETTO STRUTTURA H. 15 cm. / Assembly framework for BED FRAME HEIGHT 15 cm.



Per il montaggio necessitano 2 persone
Assembly requires 2 people

Sul lato testiera montare
staffa inferiore con doppia
foratura come Det. A
On the headboard side,
mount the lower bracket
with double holes
as shown in Fig. A.

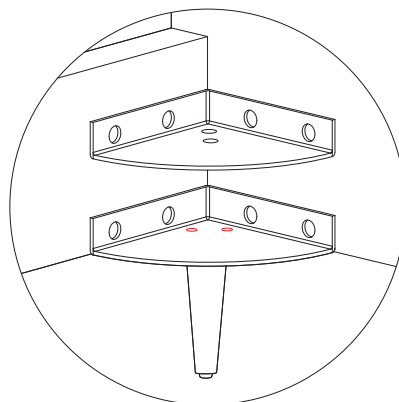

Dettaglio A
Detail A

Assemblare la struttura
del giroletto, posizionando
gli angolari come illustrato
nel dettaglio A.
Rivestire la struttura con
il tessuto. / Assemble the bed
frame structure, positioning
the corner brackets as shown
in detail A. Cover the frame
with the fabric.

122

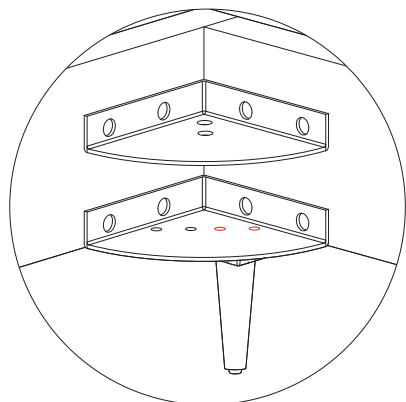
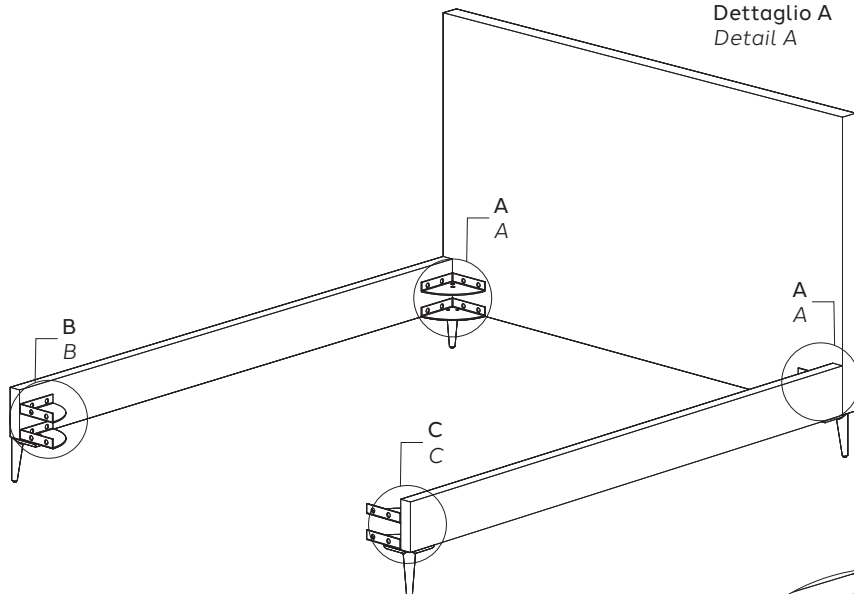

Dettaglio B
Detail B

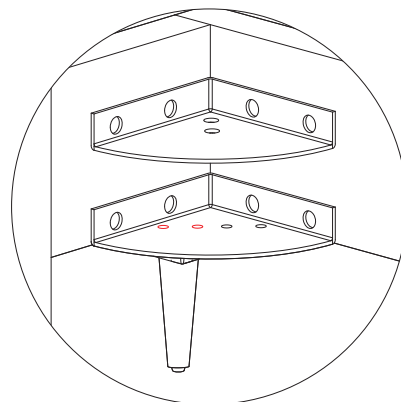

Dettaglio C
Detail C

ISTRUZIONI DI MONTAGGIO/ASSEMBLING INSTRUCTIONS

Schema di montaggio LETTO STRUTTURA H. 15 cm. / Assembly framework for BED FRAME HEIGHT 15 cm.



Per il montaggio necessitano 2 persone
Assembly requires 2 people

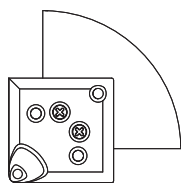

Piedini anteriori
Vedi dettaglio A
Front feet
See detail A

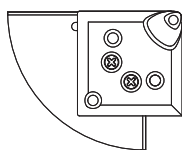

Piedino posteriore sinistro
Vedi dettaglio B
Left rear foot
See detail B

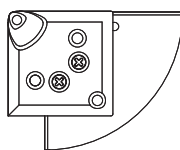

Piedino posteriore destro
Vedi dettaglio C
Right rear foot
See detail C

Montare i piedini alla struttura
seguendo le indicazioni riportate
nei disegni tecnici.
Fasten the feet to the frame
according to the instructions
in the technical drawings.

123

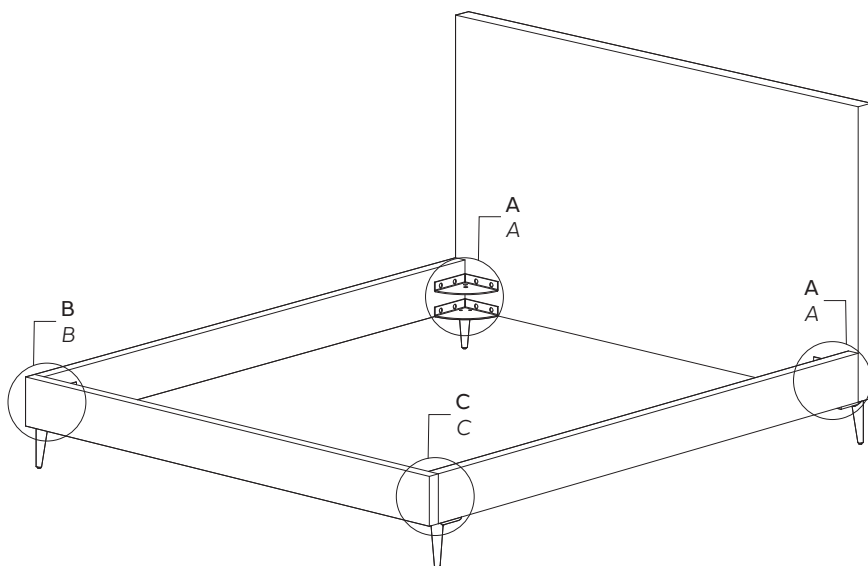

Assemblare quindi la testiera
alla struttura. / Then
assemble the headboard to
the frame.

ISTRUZIONI DI MONTAGGIO/ASSEMBLING INSTRUCTIONS

Schema di montaggio LETTO STRUTTURA H. 15 cm. / Assembly framework for BED FRAME HEIGHT 15 cm.



Per il montaggio necessitano 2 persone
Assembly requires 2 people

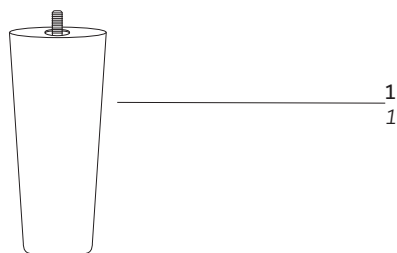

Montare i piedini alla struttura utilizzando il foro 1 degli angolari. / Fasten the feet to the frame using hole 1 in the corner brackets.

124

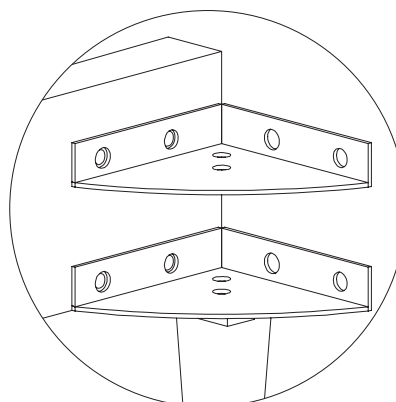
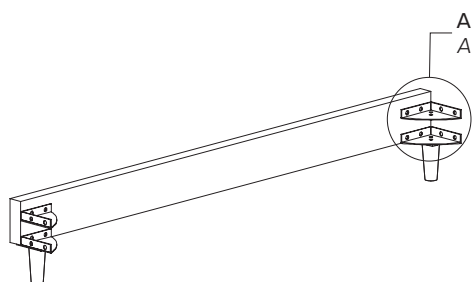

Dettaglio A, Scala 1:5 /
Detail A, Scale 1:5

Assemblare la struttura del giroletto, posizionando gli angolari come illustrato nel dettaglio A.
Rivestire la struttura con il tessuto. / Assemble the bed frame structure, positioning the corner brackets as shown in detail A.
Cover the frame with the fabric.

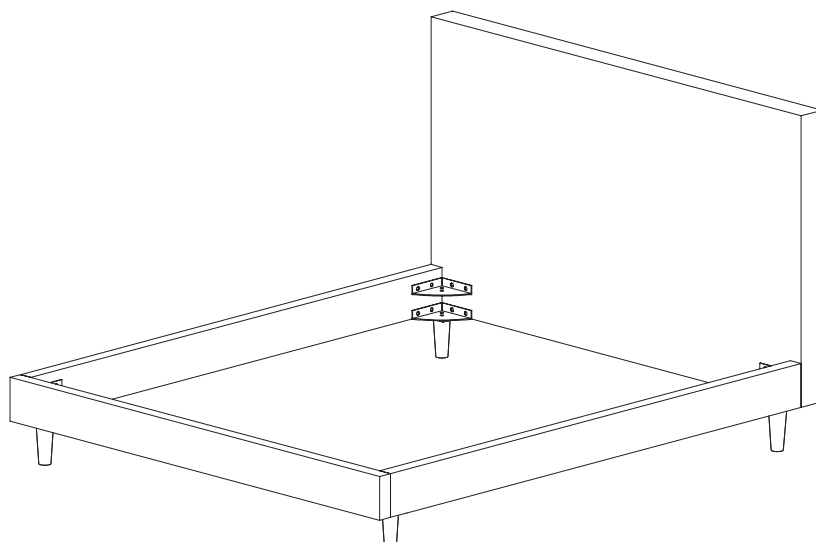

Assemblare quindi la testiera alla struttura. / Then assemble the headboard to the frame.

ISTRUZIONI DI MONTAGGIO/ASSEMBLING INSTRUCTIONS

Schema di montaggio SIRIO / Assembly framework for SIRIO BED

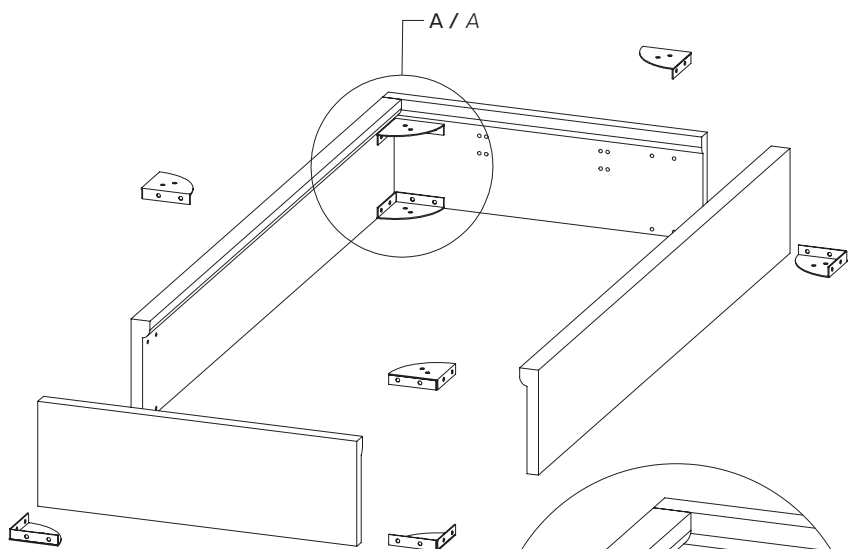

Incollare il plt adesivo ad ogni angolare e fissarli ai longoni come illustrato nel dettaglio A.
Glue the adhesive plate to each bracket and attach them to the beams as shown in detail A.

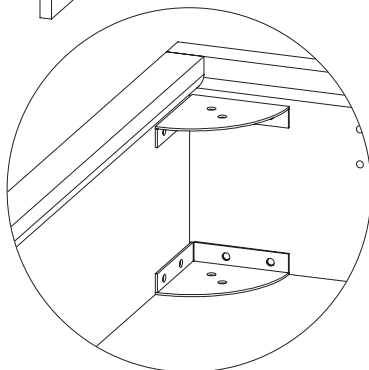

Dettaglio A Scala 1:10
Detail A Scale 1:10

125

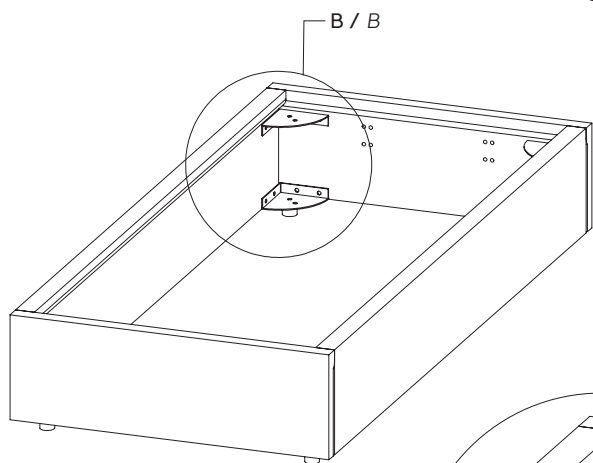

Fissare i piedi in dotazione all'angolare inferiore come illustrato nel dettaglio.
Attach the provided feet to the lower bracket as shown in the detail.

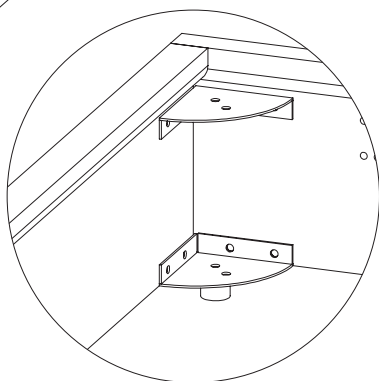

Dettaglio B Scala 1:10
Detail B Scale 1:10

ISTRUZIONI DI MONTAGGIO/ASSEMBLING INSTRUCTIONS

Schema di montaggio SIRIO CON BOX CONTENITORE STANDARD E EASY-UP /
Assembly diagram for SIRIO WITH STANDARD AND EASY-UP STORAGE BOX

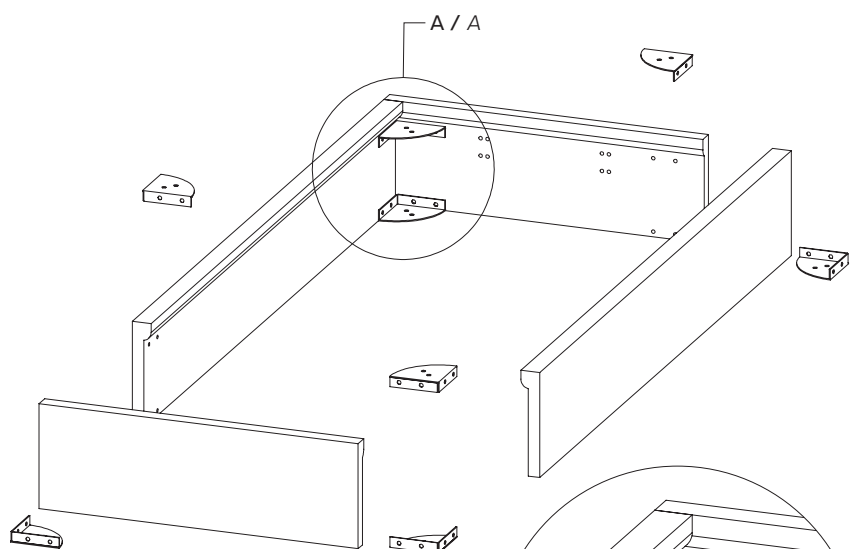

Incollare il plt adesivo ad ogni
angolare e fissarli ai longoni
come illustrato nel dettaglio A.
Glue the adhesive plate to each
bracket and attach them
to the beams as shown in detail A.

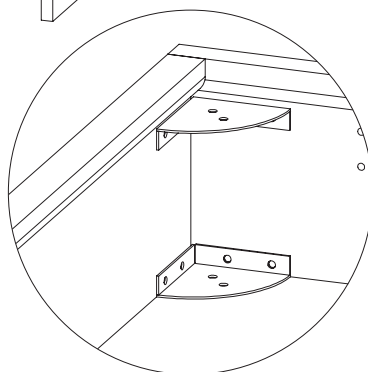

Dettaglio A Scala 1:10
Detail A Scale 1:10

126

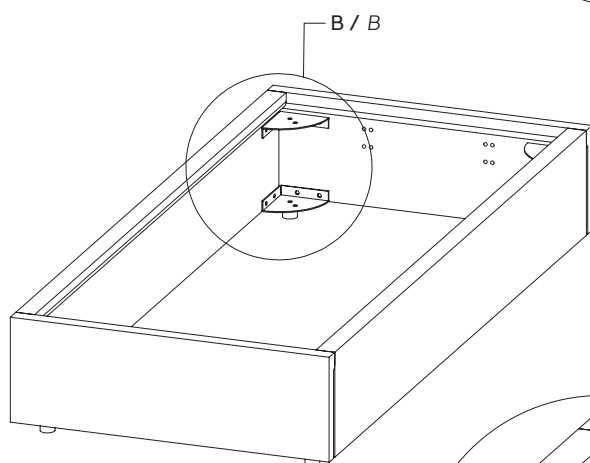

Fissare i piedi in dotazione
all'angolare inferiore come
illustrato nel dettaglio.
Attach the provided feet
to the lower bracket as
shown in the detail.

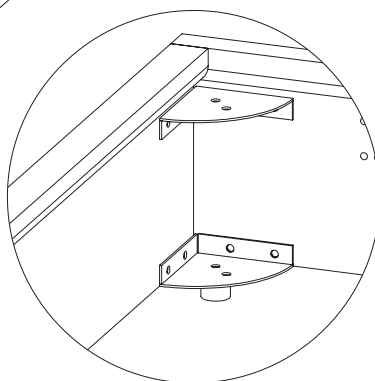

Dettaglio B Scala 1:10
Detail B Scale 1:10

ISTRUZIONI DI MONTAGGIO/ASSEMBLING INSTRUCTIONS

Schema di montaggio SIRIO CON BOX CONTENITORE STANDARD E EASY-UP /
 Assembly diagram for SIRIO WITH STANDARD AND EASY-UP STORAGE BOX

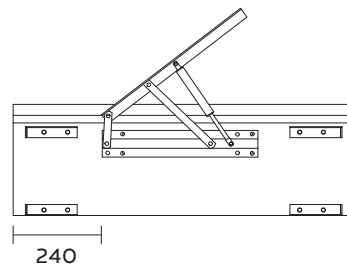
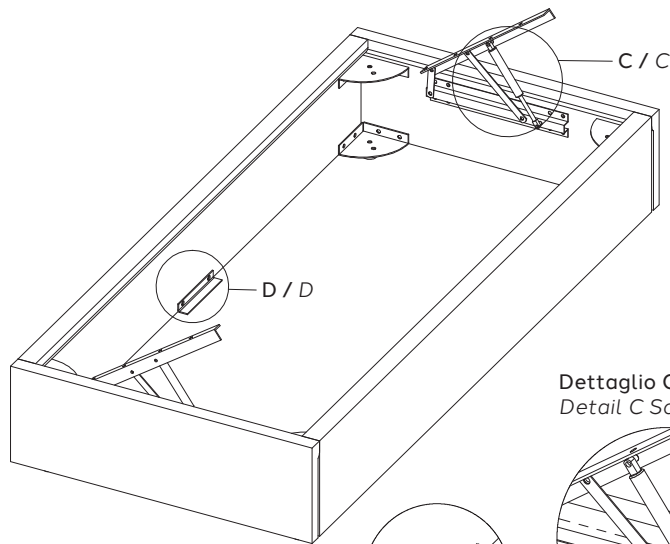

Dettaglio C Scala 1:10
 Detail C Scale 1:10

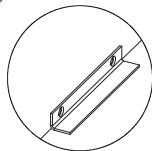

Dettaglio D Scala 1:10
 Detail D Scale 1:10

Fissare ai longoni corti i meccanismi come illustrato nel disegno, verificando la misura indicata. Montare i pistoni a gas ai meccanismi (vedi dettaglio C). Fissare ai longoni lunghi la staffa supporto fondo (vedi dettaglio D).
 Attach the mechanisms to the short side beams as shown in the drawing, checking the indicated measurement. Mount the gas pistons to the mechanisms (see detail C). Attach the bottom support bracket to the long side beams (see detail D).

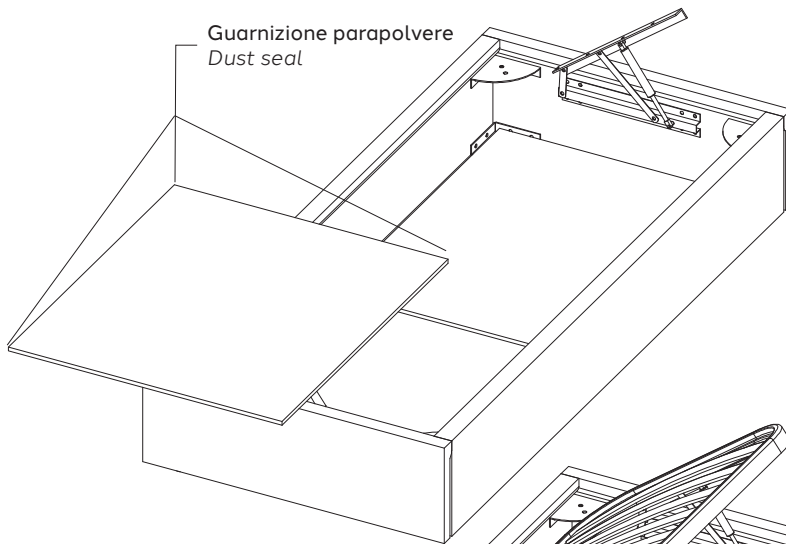

Guarnizione parapolvere
 Dust seal

Incollare lo spazzolino parapolvere ai fondi ed inserirli quindi nel vano letto.
 Glue the dust brush to the bottoms and then insert them into the bed compartment.

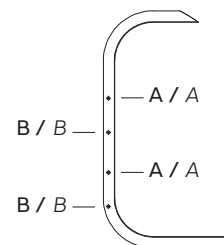
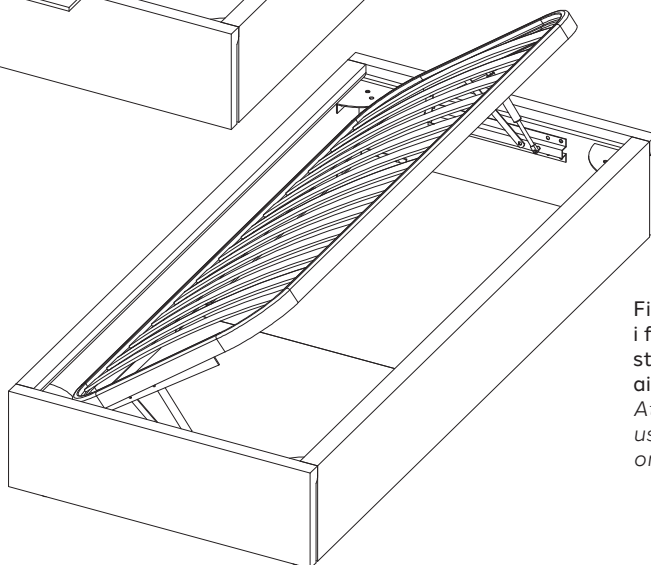

Fissare la rete ai meccanismi utilizzando i fori A per aggancio ai meccanismi standard o i fori B per aggancio ai meccanismi Easy-Up.
 Attach the bed frame to the mechanisms using holes A for standard mechanisms or holes B for Easy-Up mechanisms.

ISTRUZIONI DI MONTAGGIO/ASSEMBLING INSTRUCTIONS

Schema di montaggio SIRIO CON LETTO ESTRAIBILE / Assembly framework for SIRIO WITH PULL-OUT BED

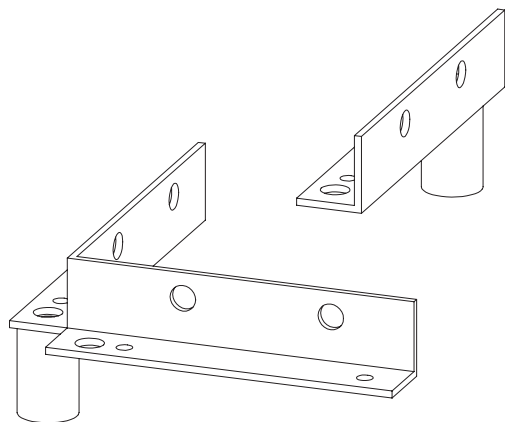

Fissare i piedi alle staffe che vanno nella parte inferiore del letto. / Attach the provided feet to the brackets to be positioned in the lower part.

128

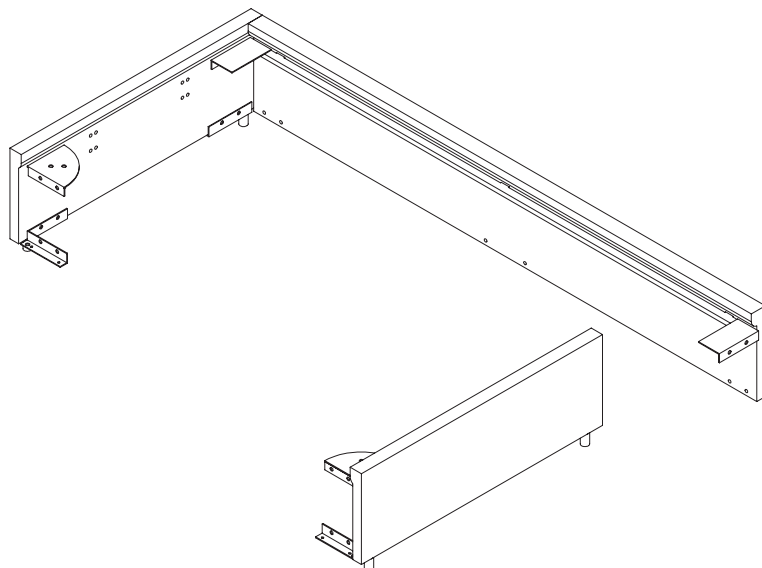

Fissare quindi le pediere al longone già provvisto di barra. Assemblare quindi il rimanente longone al letto. / Then attach the end panels to the long beam already equipped with a bar. Next, assemble the remaining long beam to the bed.

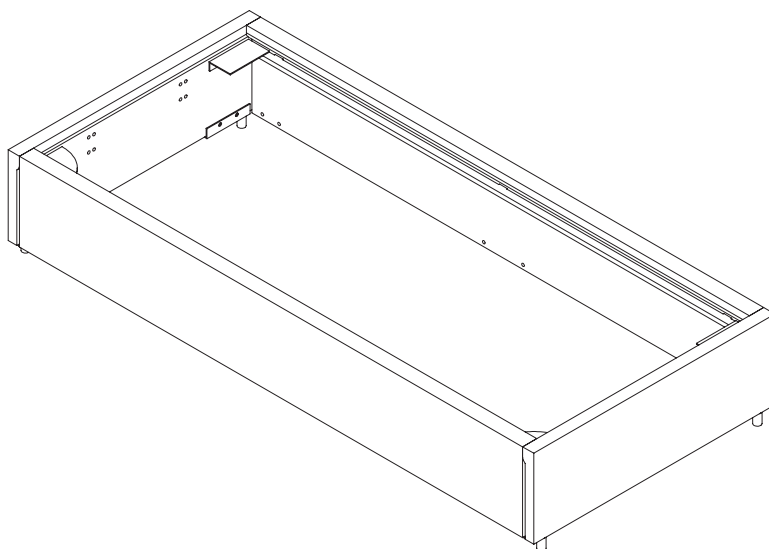

ISTRUZIONI DI MONTAGGIO/ASSEMBLING INSTRUCTIONS

Schema di montaggio SIRIO CON APERTURA AUTOMATICA / Assembly framework for SIRIO WITH AUTOMATIC OPENING

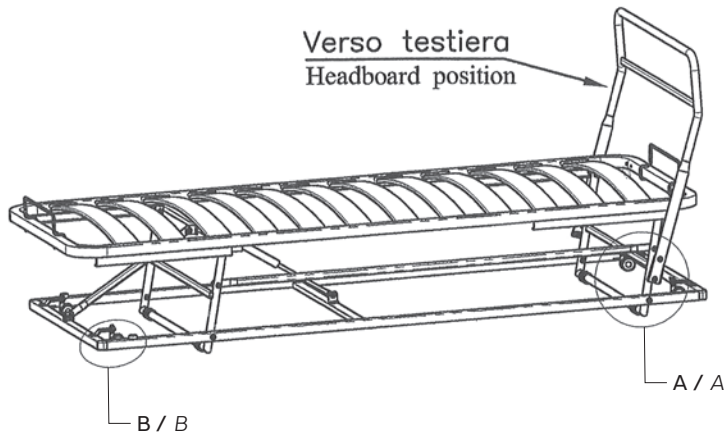

Avvitare la testiera usando le viti M8x16, inserendole, dall'esterno, come illustrato nel dettaglio A e bloccandole all'interno con i rispettivi dadi autobloccanti, rispettando il verso della testiera come illustrato. / Fix the headboard by using the M8x16 screws from the outside, as shown in detail A and lock them from the inside with the supplied self-locking nuts, paying attention to the position of the head pull as shown.

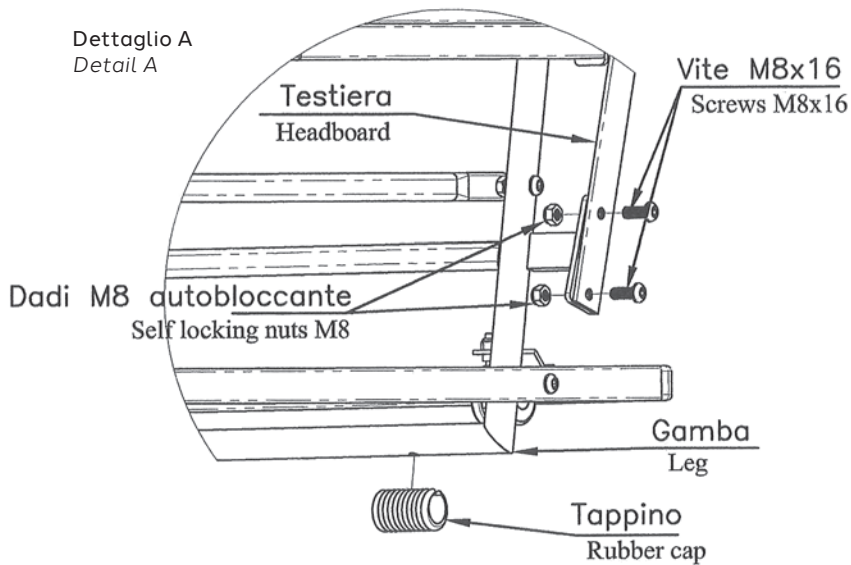

Inserire il tappino, spingendo con forza, nell'apposito foro situato nella parte inferiore della gamba come illustrato nel dettaglio A. Insert the rubber caps by pressing them into the holes on the lower part of the leg, as shown in detail A.

129

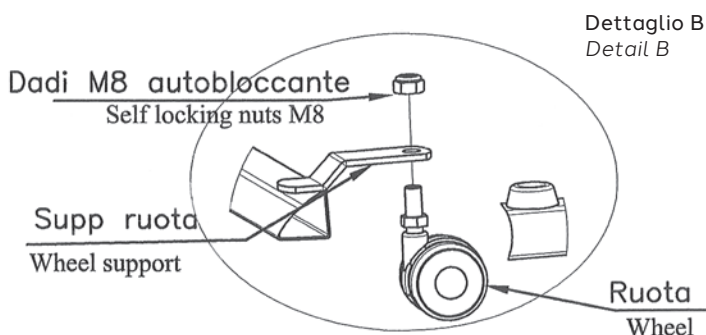

Inserire le ruote nell'apposito "supp. ruota" e bloccarle con l'apposito dado autobloccante come illustrato nel dettaglio B. Fix the wheels on the wheel supports and lock them with the self-locking nuts, as shown in detail B.

CARTELLA TESSUTI / FABRIC SAMPLES

Categoria A / Category A

Canvas



sand



brown



rose

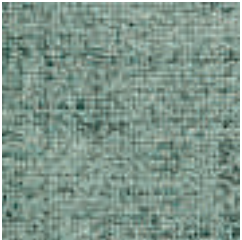

green



white



grey

130

Aragon

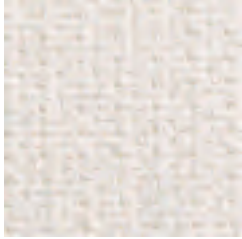

01



03

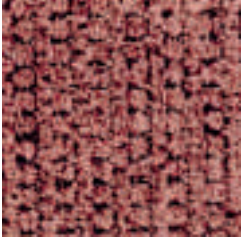

59

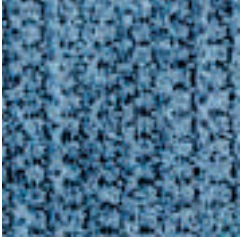

74



93



80

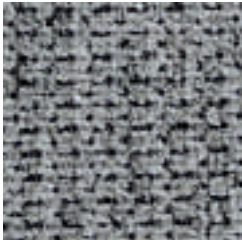

97

Cali



704



725

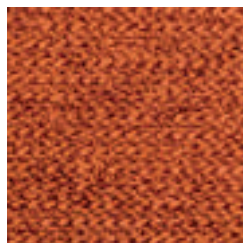

729

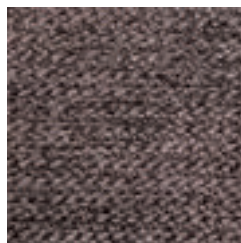

784

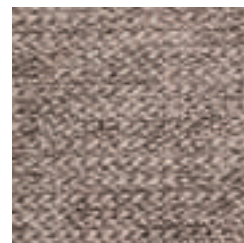

734

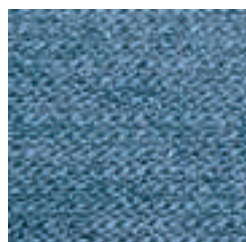

727



716

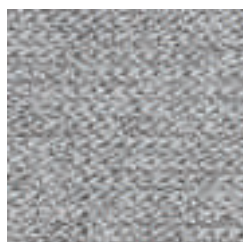

746



786

131

Seattle



16



04



74



35

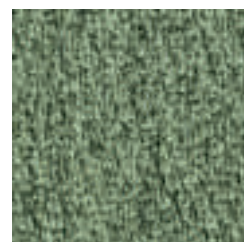

38



06



26

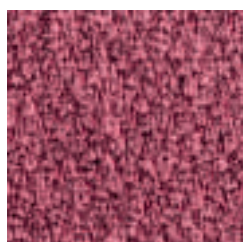

43

Quebec



04



34

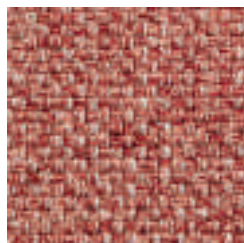

03

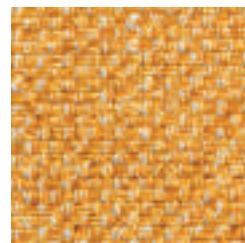

35

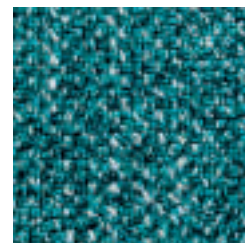

58

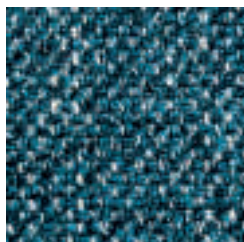

37

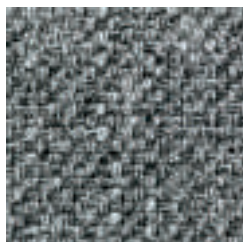

36

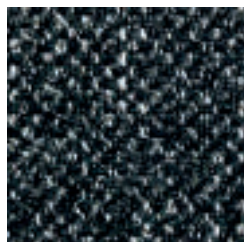

02

132

Nobilbond

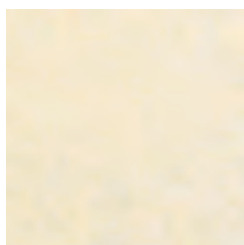

01 bianco

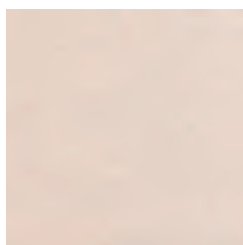

20 avorio



130 cachi

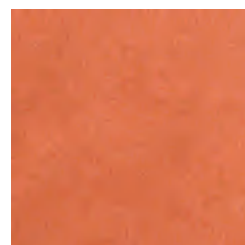

07 ruggine

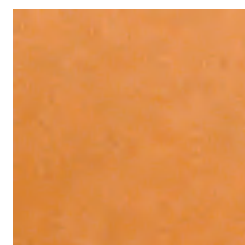

105 mandarino

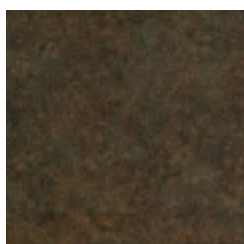

2100 bistro

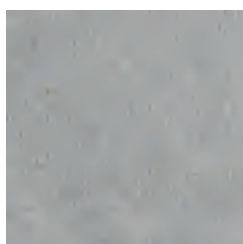

205 fumo



16 avio

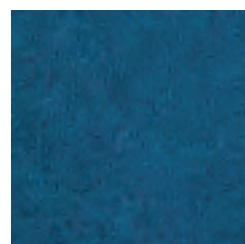

14 acquamarina

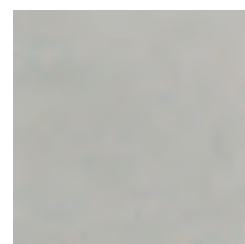

616 cenere

Bombay



01



14

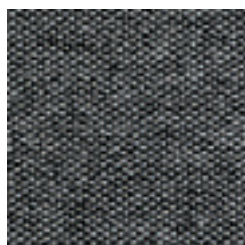

64



36



39



26

133

Miami



34



14



64



67

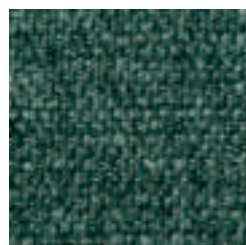

48



26



56

Pop



111



400

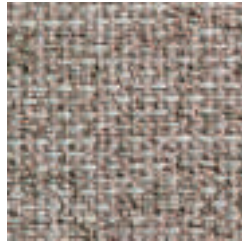

402

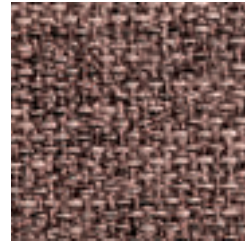

405

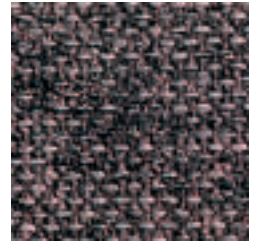

606

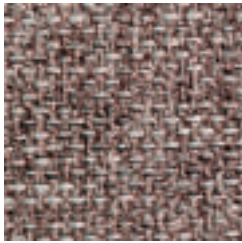

607

134

Elegant wish

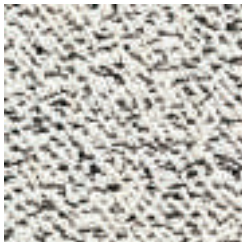

02

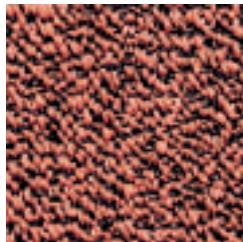

56

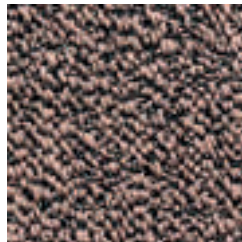

28

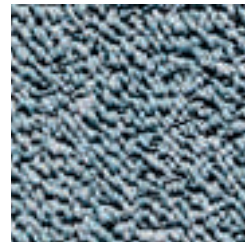

72



15

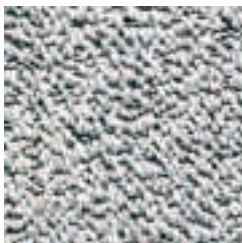

85

Now or never



03



14

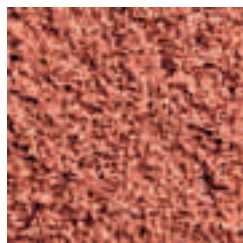

54

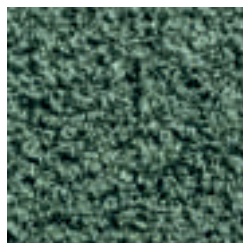

37

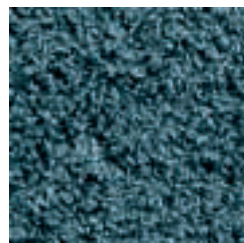

77



100

135

Toledo

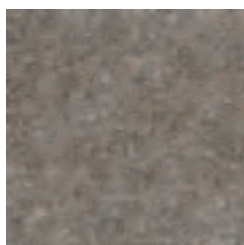

44

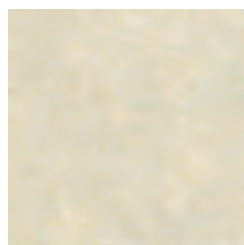

04



24



19



74



45



48

Valletta



04



34

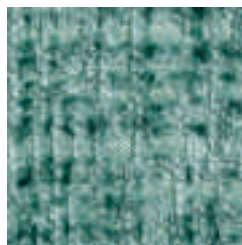

28

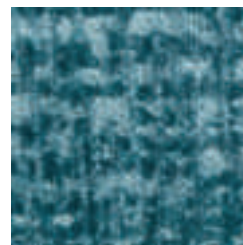

57

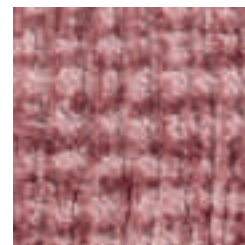

13

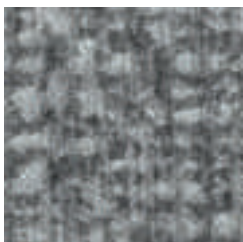

56

136

Top

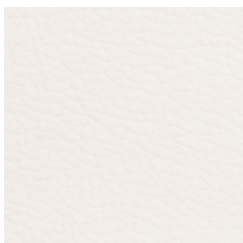

111

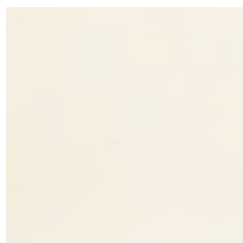

100

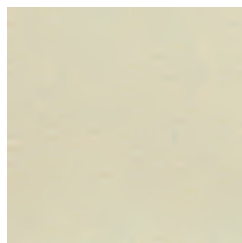

101

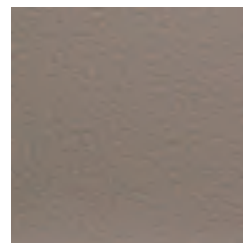

603

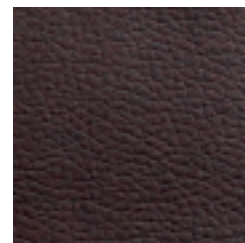

415



600



608

Arca



101

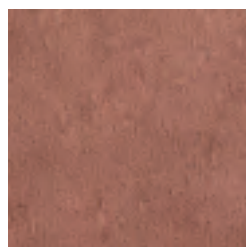

421

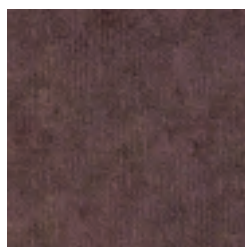

445

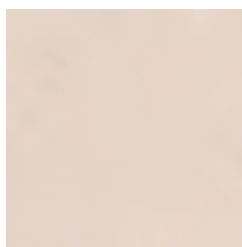

602



603

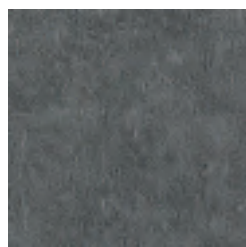

609

Spice

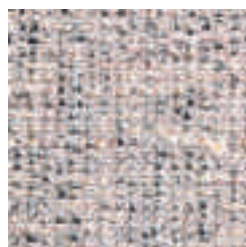

1



2

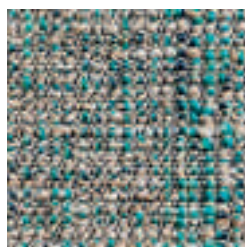

3



6

Oviedo



01

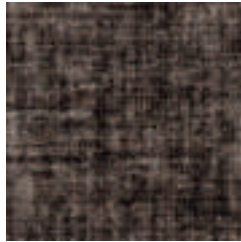

74

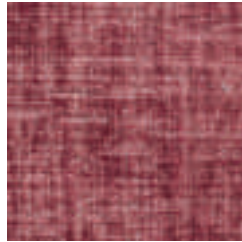

13

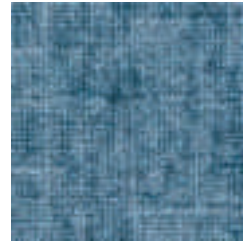

47



06

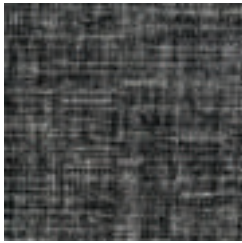

46

138

Alghero



115



20

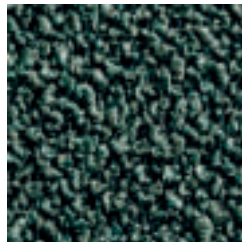

751



120

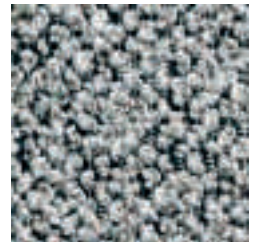

45

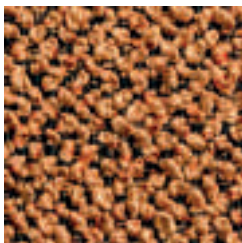

521

Pinò



Avorio 902



Tortora 905



Lotto 302

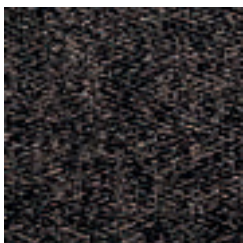

Moro 103

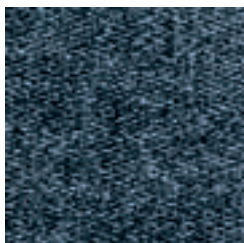

Navy 601



Antracite 801

139

Salice

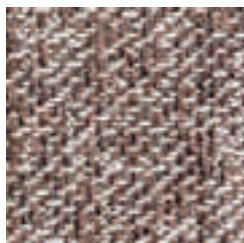

06



18



03

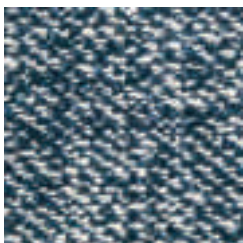

17

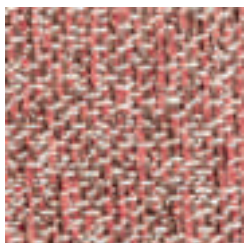

12

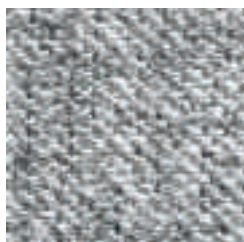

20

Cruise Chenille



02

Solemio

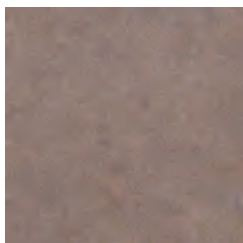

03

Cruise Melange

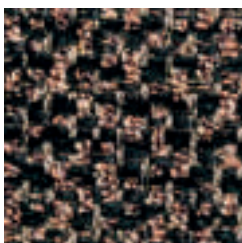

140

02

Solemio

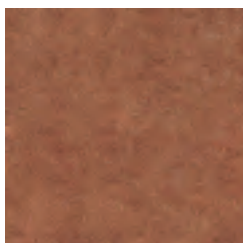

107

Cachemire

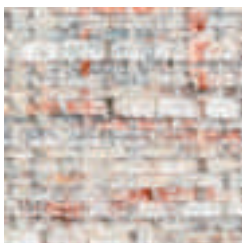

400

Solemio



06

Cachemire

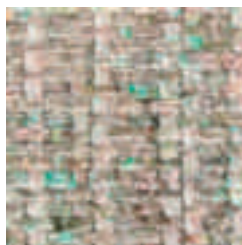

800

Solemio



09

Cachemire



500

Solemio



17

Cachemire

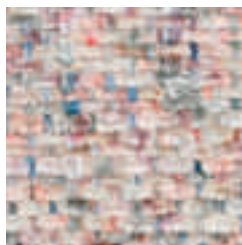

401

Solemio



123

141

I tessuti della Collezione Coordinati devono essere utilizzati esclusivamente come proposti e non possono essere separati o mischiati con tessuti di altre cartelle. / *The fabrics in the Collezione Coordinati must be used exactly as presented and cannot be separated or mixed with other fabrics.*

PIEDINI / FEET

La gamma di piedini si arricchisce con nuove forme e finiture, offrendo soluzioni eleganti e resistenti. / The range of feet is enriched with new shapes and finishes, offering elegant and durable solution.

142



Conico h.8
Conical h.8

nero laccato
lacquered black

Conico h.8
Conical h.8

wengé
wenge

Conico h.8
Conical h.8

noce canaletto
canaletto walnut

Conico h.8
Conical h.8

naturale
natural

Conico h.8
Conical h.8

rovere sbiancato
bleached oak

Cilindro h.4
Cylinder h.4

nero laccato
lacquered black

Sagomato h.8
Shaped h.8

naturale
natural

Sagomato h.8
Shaped h.8

nero laccato
lacquered black

Sagomato h.8
Shaped h.8

wengé
wenge

Metallo angolare h.13
Angular metal h.13

metallo nero
black metal



Condizioni generali di vendita

*Con il conferimento dell'ordine si accettano, senza necessità di espressa dichiarazione, le seguenti Condizioni Generali di Vendita.

Ordini

Gli ordini sono sempre condizionati dalla clausola "Salvo approvazione della Casa". Gli ordini con consegna richiesta oltre i 60 gg. verranno evasi applicando il listino in vigore al momento della spedizione, salvo diversi accordi da confermare per iscritto da parte dell'azienda Mita Srl.

Non si accettano annullamenti di ordinativi oltre i 3 giorni lavorativi dal ricevimento della conferma dell'ordine e in nessun caso per gli articoli realizzati su misura.

Prezzi

I prezzi indicati all'interno del seguente listino si intendono al pubblico in unità di Euro, **IVA inclusa**. Potrebbero subire in qualsiasi momento variazioni in ragione degli aumenti delle materie prime, del costo della manodopera e quant'altro potrà verificarsi in maniera imprevedibile o per ragioni di mercato e/o errori di stampa. I prezzi si intendono per consegna presso il rivenditore.

Vendita on-line

La vendita dei prodotti attraverso le piattaforme on-line è consentita al rivenditore nella misura in cui promuove e propone i prodotti a marchio Ennerev all'interno di piattaforme on-line, siti e-commerce di rivenditori e/o piattaforme comparative di prezzo a prezzo di listino al pubblico in vigore, ovvero ai prezzi che Ennerev consiglia sul proprio listino, senza l'applicazione di sconti ulteriori. Politiche di vendita audaci, non autorizzate, fuorvianti o che avvengano con la pubblicazione di qualsiasi sconto sui prezzi consigliati porteranno all'interruzione di fornitura nei tempi e nei modi previsti da usi e consuetudini commerciali.

Prodotti

Le descrizioni e le caratteristiche dei prodotti richiamate nel presente catalogo sono puramente indicative e non vincolanti. L'azienda Mita Srl si riserva il diritto di modificarle, senza alcun preavviso. Le misure dei prodotti sono espresse in centimetri. L'azienda Mita Srl garantisce le misure più precise possibili riservandosi tuttavia una tolleranza delle stesse di cm. 2 in più o in meno in larghezza, lunghezza e altezza. Tutte le misurazioni sono effettuate con riferimento alla norma UNI EN 1334. Per i prodotti su misura, richiederne preventivamente la fattibilità.

Finiture

La tonalità cromatica dei materiali, dei tessuti o altro potrebbero variare rispetto alla documentazione fotografica e al campionario "Fabric Samples".

Lavorazione con tessuto cliente

Il tessuto occorrente per confezionare il prodotto è espresso in metri lineari in altezza cm 140 di utile (escluso pelle). Il consumo si riferisce a tessuti in tinta unita. Per tessuti diversi dai precedenti, contattare il nostro ufficio vendite. Il tessuto cliente dovrà pervenire in azienda in porto franco con relativa bolla di accompagnamento; in caso contrario sarà rifiutato e rispedito al mittente senza alcun preavviso. Mita Srl non accorda nessuna garanzia sui rivestimenti realizzati con tessuto cliente. La lavorazione "tessuto cliente" non è prevista per la pelle.

Consegna

La consegna della merce ordinata verrà effettuata con la massima sollecitudine secondo le disponibilità di magazzino e di produzione. Eventuali termini di consegna inseriti nell'ordine non devono considerarsi tassativi. La mancata o ritardata consegna della merce, anche se pattuita, o per causa di forza maggiore non costituisce alcun diritto, per il cliente o altri, per richiedere il risarcimento per danni o altro. La merce, indipendentemente dalla forma di spedizione, viaggia a rischio e pericolo dell'acquirente. Per importi inferiori a euro 300,00 verrà addebitato in fattura un importo netto forfettario pari a euro 30,00 per il trasporto.

Non si effettuano consegne a privati.

Reclami

I reclami per mancanza, non conformità e vizi palesi della merce devono essere segnalati per iscritto immediatamente al momento della consegna e comunque entro 8 gg dal ricevimento della stessa pena la decadenza di tale diritto.

Garanzia di idoneità del prodotto

I difetti occulti sul prodotto sono coperti da garanzia a norma di legge (D.Lgs. 02 Febbraio 2002 n° 24) con esclusione dei difetti dovuti ad uso improprio del prodotto o difetti causati da una evidente carenza delle norme di manutenzione riportate nella specifica documentazione. La garanzia a norma di legge decorre dalla data di acquisto che deve essere documentata dallo scontrino fiscale, dalla fattura o dalla ricevuta fiscale.

Resi

Non si accettano resi di merce, se non espressamente autorizzati per iscritto dall'azienda. La merce autorizzata al reso dovrà pervenire in azienda con idoneo imballo e in porto franco. In caso contrario il reso, anche se autorizzato, non sarà accettato.

Pagamenti

Tutti i pagamenti saranno considerati validi se effettuati direttamente all'azienda. Il mancato rispetto dei termini di pagamento comporta il diritto della messa in mora del debitore con addebito degli interessi ai tassi bancari in corso e il recupero di eventuali sconti valuta. Nel caso sia convenuto un pagamento dilazionato, la proprietà della merce si intende riservata all'azienda.

Validità

Il presente listino è valido dal 01/09/2024. Annulla e sostituisce il precedente. L'azienda non risponde per eventuali errori di stampa relativi a prezzi, misure, caratteristiche tecniche, etc. indicate nel presente listino.

Foro competente

Per qualsiasi azione o controversia si intende fissata in via esclusiva la competenza del Foro di Treviso.

General conditions of sale

**By placing an order the following General Conditions of Sale are taken as accepted without the need to specifically express this.*

Orders

Orders are always "subject to manufacturer's approval". Orders with delivery required beyond 60 days shall be executed according to the price list in force at the time of dispatch, unless otherwise agreed in writing by Mita Srl. Cancellations made later than 3 working days after placing the order are not accepted. Orders for bespoke items cannot be cancelled.

Prices

The prices indicated in the valid price list are to be considered public and in Euro, **including VAT**. They may change at any time due to increases in raw materials, labor costs, or any other unforeseen circumstances or market reasons and/or printing errors. Prices are intended for delivery to the retailer.

Online Sales

The sale of products through online platforms is permitted to the retailer to the extent that they promote and offer Ennerev-branded products on online platforms, e-commerce sites of retailers, and/or price comparison platforms at the current public price list, that is, at the prices recommended by Ennerev on their price list, without applying additional discounts. Bold, unauthorized, misleading sales policies or sales that occur with the publication of any discounts on the recommended prices will lead to the suspension of supply in the timeframes and manners provided by commercial customs and practices.

Products

The descriptions and characteristics of the products given in this catalogue are merely indicative and not binding. Mita Srl reserves the right to alter them without notice. Measurements are expressed in centimeters. Mita Srl guarantees measurements as precise as possible, with a tolerance of ± 2 cm. in width, length and height. All measurements observe UNI EN 1334 Standards. For bespoke products, request feasibility before ordering.

Finishes

The shades of colour for fabrics or other may be different from the photographs or swatches for the "Fabric Samples".

Customers' fabrics

The fabric required to make up the product is expressed in linear meters with a working width of 140 cm (excluding leather). The measurements refer to plain coloured fabric. For fabrics different from this, please contact our sales office. Customers' fabric must be sent to us postage paid with relative delivery note; if these conditions are not applied the fabric will be rejected and returned to the sender without notice. Mita Srl does not guarantee covers made with customers' fabric. Customers' fabric items do not include leather.

Delivery

Delivery of the goods ordered will take place as promptly as possible, according to stock availability and production. Any delivery terms included in the order shall not be considered binding. Failed or delayed delivery of goods, even if agreed or due to force majeure shall not give customers or others the right to claim damages or anything else. Goods travel at the purchaser's risk, independently of the type of transport. For amounts below euro 300.00 a lump sum of € 30.00 will be added to the invoice for transport. Deliveries are not made to private citizens. Delivery terms for foreign orders is FCA Volpago del Montello.

Complaints

Complaints for shortages, non-conformity, and obvious defects of the goods must be reported in writing immediately upon delivery and in any case within 8 days of receipt, under penalty of forfeiture of such right.

Warranty

Hidden faults on the products are covered by a warranty under the terms of Italian law (Legislative Decree No. 24 of 2 February 2002); with the exclusion of faults caused by inappropriate use of the products or evident negligence in observing the maintenance instructions in the special document. By law the warranty is valid from the date of purchase and must be completed with a bill, invoice or receipt valid for tax purposes.

Returns

Returns of goods are not accepted unless expressly authorized in writing by the company. Authorized returns must be sent to the company with appropriate packaging and freight prepaid. Otherwise, the return, even if authorized, will not be accepted.

Payment

All payments shall be considered valid if made directly to the company. Failure to comply with payment terms grants the right to charge the debtor interest at current bank rates and to recover any discounts given. In the event of an agreed deferred payment, ownership of the goods is reserved for the company.

Validity

This catalogue is valid from 01/09/2024 and nulls and replaces the previous one. Mita Srl is not responsible for any printing errors regarding prices, measurements, technical characteristics, etc. that may be found in the price list.

Competent court

For any proceedings or controversy arising here from, exclusive competence lies with the Court of Treviso.

ENNEREV®

Via Schiavonesca Nuova 22
31040 Volpago del Montello TV
tel. +39 0423 620521
info@ennerev.it

Designer

Matteo Zorzenoni

Concept & Graphic Design

Design Associati

Photo e render

Photografica

Styling

Patrizia Toffolo

Printing

Grafiche Antiga

www.ennerev.it